

LAMPADE

LED, FARI E FANALI

7



CAPITOLO 7

- Lampade LED e xenon
- Fari da lavoro LED
- Lampeggianti e multiflash LED
- Fari e fanali
- Barre lampeggianti LED
- Plafoniere LED

LAMPADE

FARI E FANALI

GUIDONI
TEST THE DIFFERENCE

LAMPADE XENON



CODICE	CARATTERISTICHE	ATTACCO	CF. 
FK120144	D1S 85V-35W	PK32D-2	1PZ.
FK126150	D1R 85V-35W	PK32D-3	1PZ.
FK120340	D3S 42V-35W	PK32D-5	1PZ.
FK126540	D5S 12V-25W	PK32D-2	1PZ.
FK126548	D8S 42V-25W	PK32D-1	1PZ.



CODICE	CARATTERISTICHE	ATTACCO	CF. 
FK120240	D2S 85V-35W	P32D-2	1PZ.
FK120250	D2R 85V-35W	P32D-3	1PZ.
FK120440	D4S 42V-35W	P32D-5	1PZ.
FK120450	D4R 42V-35W	P32D-6	1PZ.

LAMPADE ALOGENE



CODICE	CARATTERISTICHE	ATTACCO	CF. 
FK120210	H7 12V-55W	PX26D	1PZ.
FK120180L	H18 12V-65W	PY26D-1	1PZ.
FK120181L	H19 12V-60/55W	PU43T	1PZ.
FK120215	H7 24V-70W	PX26D	1PZ.



CODICE	CARATTERISTICHE	ATTACCO	CF. 
FK120193	H4 12V-60/55W	P43T	1PZ.
FK240196	H4 24V-75/70W	P43T	1PZ.



FK127951 10 pz. 

Lampada asimmetrica 12V attacco P45T



7- Lampade LED e xenon



FK127183

10 pz.

Lampada H5 12V-60/55W attacco P45T



FK120150

10 pz.

Lampada H1 12V-55W attacco P14,5S



FK120151

10 pz.

Lampada H3 12V-55W attacco PK22S



CODICE	CARATTERISTICHE	ATTACCO	CF.
FK129005	HB3 12V-65W	9005-P20D	1PZ.
FK129006	HB4 12V-51W	9006-P22D	1PZ.
FK120212	H8 12V-35W	PGJ19-1	1PZ.
FK120213	H9 12V-65W	PGJ19-5	1PZ.
FK120145	H10 12V-42W	PY20D	1PZ.
FK120211	H11 12V-55W	PGJ19-2	1PZ.
FK120241	H11B 12V-55W	PGJ19-2	1PZ.
FK120055	H12 12V-53W	90055-PZ20D	1PZ.
FK120219	H16 12V-19W	PGJ19-3	1PZ.
FK120012	HIR2 12V-55W	9012-PX22D	1PZ.



CODICE	CARATTERISTICHE	ATTACCO	CF.
FK120008	H13 12V-60/55W	PJ26,4	1PZ.
FK120176	H15 12V-55/15W	PGJ23T-1	1PZ.
FK120881	H27/2 12V-27W	881-PGJ13	1PZ.



COPPIE DI LAMPADE ALOGENE

SUPER WHITE e +130%



CODICE	CARATTERISTICHE	CF. 
FK12193CB	COPPIA DI LAMPADE H4 12V COOL BLUE KIT	2PZ.
FK12210CB	COPPIA DI LAMPADE H7 12V COOL BLUE KIT	2PZ.
FK12H4130	COPPIA DI LAMPADE H4 12V +130% DI LUCE	2PZ.
FK12H7130	COPPIA DI LAMPADE H7 12V +130% DI LUCE	2PZ.
FK24H4130	COPPIA DI LAMPADE H4 24V +130% DI LUCE	2PZ.
FK24H7130	COPPIA DI LAMPADE H7 24V +130% DI LUCE	2PZ.

LAMPADE AUSILIARIE



CODICE	CARATTERISTICHE	CF. 
FK122721	LAMPADA 12V-1,2W VETRO T5	10PZ.
FK242741	LAMPADA 24V-5W VETRO T5	10PZ.



CODICE	CARATTERISTICHE	CF. 
FK122825	LAMPADA 12V-5W VETRO T10	10PZ.
FK242845	LAMPADA 24V-5W VETRO T10	10PZ.



CODICE	CARATTERISTICHE	CF. 
FK120921	LAMPADA 12V-16W VETRO T15	10PZ.
FK12921NA	LAMPADA 12V-16W VETRO T15 ARANCIO	10PZ.



CODICE	CARATTERISTICHE	CF. 
FK127505	LAMPADA 12V-21W VETRO T20	10PZ.
FK127515	LAMPADA 12V-21W/5W VETRO T20 BILUCE	10PZ.



7- Lampade LED e xenon



CODICE	CARATTERISTICHE	ATTACCO	CF.
FK127506	12V-21W	BA15S	10PZ.
FK127507	12V-21W ARANCIO	BAU15S	10PZ.
FK247511	24V-21W	BA15S	10PZ.
FK247510	24V-21W ARANCIO	BAU15S	10PZ.



CODICE	CARATTERISTICHE	ATTACCO	CF.
FK127528	12V-21W/5W	BAY15D	10PZ.
FK127225	12V-21W/4W	BAZ15D sfalsata	10PZ.
FK247537	24V-21W/5W	BAY15D	10PZ.



CODICE	CARATTERISTICHE	ATTACCO	CF.
FK125007	12V-5W SFERA	BA15S	10PZ.
FK125008	12V-10W SFERA	BA15S	10PZ.
FK245627	24V-5W SFERA	BA15S	10PZ.
FK245637	24V-10W SFERA	BA15S	10PZ.



CODICE	CARATTERISTICHE	ATTACCO	CF.
FK123893	12V-4W SPIA	BA9S	10PZ.
FK243930	24V-4W SPIA	BA9S	10PZ.



CODICE	CARATTERISTICHE	ATTACCO	CF.
FK126418	12V-5W SILURO	SV8,5 - 11X38	10PZ.
FK126438	12V-10W SILURO	SV8,5 - 10X31	10PZ.
FK246423	24V-5W SILURO	SV8,5 - 11X38	10PZ.
FK246429	24V-10W SILURO	SV8,5 - 11X38	10PZ.



FK120132 10 pz.

Lampada **H6** 12V 6W attacco BAX9S



FK120136 10 pz.

Lampada **H21** 12V 21W attacco BAY9S



7- Lampade LED e xenon



FK12024W 1 pz.

Lampade a incandescenza serie **PS24W**
12VOLT 24WATT
attacco **PG20/7** per peugeot



FK12Y24W 1 pz.

Lampade a incandescenza serie **PY24W**
12VOLT 24WATT colore **arancio**
attacco **PGU20/4** per BMW



FK12019W 1 pz.

Lampade a incandescenza serie **PS19W**
12VOLT 24WATT
attacco **PG20/1** per AUDI



FK12X24W 1 pz.

Lampade a incandescenza serie **PSx24W**
12VOLT 24WATT
attacco **PG20/7** per peugeot



FK12K24W 1 pz.

Lampade a incandescenza serie **PW24W**
12VOLT 24WATT

LAMPADE LED T5



OSR9900 2 pz.

Lampade led smd serie **T5 12V**, tutto vetro. **1,2WATT**
bianche, attacco **w2x4,6d**.

LAMPADE LED T10



OSR9901/5OS 2 pz.

Lampade LED **12V 5W** vetro **T10** bianca con
chip osram cambus

Marchio Guidoni.



WARNING CANCELLER PER LAMPADE LED



OSR9916 2 pz.

Resistenza led smd **12V** spegni spia, serie **T10**

Marchio Guidoni.

CODICE	VOLT	WATT	CF.
OSR9908-1	12V	5W	1 COPPIA
OSR9909-1	12V	21W	1 COPPIA
OSR9910	24V	5W	1PZ.
OSR9911	24V	21W	1PZ.



OSR9903 2 pz.

Resistenza led **12V-4W** colore **bianco** e attacco **ba9s**

Marchio Guidoni.



OSR9877 2 pz.

Lampada LED **bax9s** H6, **12/24V** canbus **12V**

OSR9876 2 pz.

Lampada LED **baY9s** H21, **12/24V** canbus **12V**

Marchio Guidoni



LAMPADE ATTACCO BA15D

OSR9906 2 pz.

Lampade LED **12V** , bianche, attacco **ba15s**

Marchio Guidoni.

OSR9907 2 pz.

Lampade LED **12V**, attacco **ba15d**

Marchio Guidoni.



LAMPADE ATTACCO BA15S

OSR9905 2 pz.

Lampade LED **12V-5W**, bianche a sfera con attacco **ba15s**

Marchio Guidoni.



LAMPADE LED SILURO

Lampade canbus siluro a 6LED smd **12-24VOLT 4,5WATT**, attacco **sv8**, bianche, per auto e camion.

Marchio Guidoni.



CODICE	ATTACCO	VOLT	WATT	LUNGHEZZA	CF.
OSR9873	SV8	12-24V	4,5W	31MM	2PZ.
OSR9874	SV8	12-24V	4,5W	36MM	2PZ.
OSR9984	SV8	12-24V	4,5W	39MM	2PZ.
OSR9875	SV8	12-24V	4,5W	41MM	2PZ.

LAMPADE LED HIGH POWER

Lampade LED **12-24V**, colore bianco high power con attacco **ba15s**.



CODICE	ATTACCO	VOLT	WATT	COLORE	CF.
OSR9882	BA15S	12-24V	16W	BIANCO	2PZ.
OSR9883	BA15S	12-24V	16W	ARANCIO	2PZ.



OSR9884 2 pz.

Lampade led **12-24volt 16W**, colore bianco high power biluce con attacco **ba15d**

Marchio Guidoni.

LAMPADE LED HIGH POWER FULLCANBUS



OSR9700LLV 2 pz.

Lampada LED **T20 12V**
 - canbus W3X16D 200-7515 colore **bianco**
 - monoluce con ventola di raffreddamento e lente



OSR9701LLV 2 pz.

Lampada LED **T20 12V**
 - canbus W3X16D
 200-7505 colore **bianco**
 - biluce con ventola di raffreddamento e lente



OSR9888 2 pz.

Lampada LED **BAU15S 12/24V**
 - canbus colore **arancio**
 - con ventola di raffreddamento e lente

7- Lampade LED e xenon



ELE5305

2 pz.

Intermittenza **12V** specifica per lampade a LED con battito freccia regolabile per vetture europee.

LAMPADE LED T15 TUTTO VETRO



OSR9703L

2 pz.

Lampade LED **T15** tutto vetro - 921 **12-24V** 11w, colore **bianco**

LAMPADE LED T20 MONOLUCE E BILUCE



Dettagli articoli:

Lampade LED serie **T20 12V/21W** W3x16d 200-7505 da **12-24V** e 11W, **Monoluce**.

CODICE	SERIE	VOLT	WATT	COLORE	CF.
OSR9700L	T20	12-24V	11W	BIANCO	2PZ.
OSR9704L	T20	12-24V	11W	ARANCIO	2PZ.

Dettagli articoli:

Lampade LED serie **21/5W** w3x16d 200-7515 da **12-24V** e **11watt**, **Biluce**.



CODICE	SERIE	VOLT	WATT	COLORE	CF.
OSR9701L	T20	12-24V	11W	BIANCO	2PZ.
OSR9701LA	T20	12-24V	11W	ARANCIO	2PZ.

LAMPADE LED W2.5X16Q MONOLUCE E BILUCE



Dettagli articoli:

Lampade led serie w2,5x16q da 12-24volt e 11 watt, **biluce**. Facile installazione e massima qualità.

Marchio Guidoni.

CODICE	SERIE	VOLT	WATT	COLORE	CF.
OSR9706L	W2,5X16Q	12-24V	11W	BIANCO	2PZ.
OSR9707L	W2,5X16Q	12-24V	11W	ARANCIO	2PZ.

Dettagli articoli:

Lampade led serie w2,5x16d da 12-24volt e 11 watt, **monoluce**. Facile installazione e massima qualità.

Marchio Guidoni.



CODICE	SERIE	VOLT	WATT	COLORE	CF.
OSR9708L	W2,5X16D	12-24V	11W	BIANCO	2PZ.
OSR9709L	W2,5X16D	12-24V	11W	ARANCIO	2PZ.



LAMPADE LED SMD PER CRUSCOTTO



OSR9000L 2 pz.

Lampada LED 12v 1.2W 2721 mf8



OSR9001L 2 pz.

Lampada LED 12V 1.2W 2721 mf



CODICE	VOLT	DIAMETRO	CF.
OSR9760	12V	8mm	2PZ.
OSR9761	12V	10mm	2PZ.
OSR9762	12V	12mm	2PZ.

LAMPADE LED 24V



OSR9930 2 pz.

Lampade LED smd serie **T5, 24V** tutto vetro, **bianche**



OSR9920 2 pz.

lampada a led **24V-5W**, vetro, T10 **bianche**



OSR9925 2 pz.

Lampade led smd **24V, bianche** attacco BA9S



OSR9922 2 pz.

Lampade led smd serie **24V, bianche** attacco **BA15S** sostituisce **24V/5W** sfera **BA15S**



OSR9923 2 pz.

Lampade LED smd serie **12/24V bianche** attacco **BA15S** sostituisce **BA15S 24V/12W**



OSR9929 2 pz.

Lampade LED **BAY15D** sostituisce **BAY15D 24V-21W/5W** biluce

KIT LED CANBUS TOP QUALITY



10000 lumen per
lampada
12-24V

dettagli articoli:

KIT lampade LED canbus MOD.F3 con ventola

CODICE	DESCRIZIONE	VOLT/WATT	LUMEN
OSR9830	H7	12/24V- 45W	10000
OSR9831	H4	12/24V- 45W	10000
OSR9832	H8	12/24V- 45W	10000
OSR9833	H10	12/24V- 45W	10000
OSR9834	H11	12/24V- 45W	10000
OSR9835	HB3	12/24V- 45W	10000
OSR9836	HB4	12/24V- 45W	10000
OSR9837	HIR2	12/24V- 45W	10000

KIT LED CANBUS



dettagli articoli:

KIT LED high power canbus

12/24V

CODICE	DESCRIZIONE	VOLT/WATT	LUMEN
OSR9985-1	H7	12/24V- 60W	12000
OSR9985-2	H4	12/24V- 60W	12000
OSR9985-3	H1	12/24V- 60W	12000
OSR9985-4	H8 e H11	12/24V- 60W	12000



KIT LED PLUG AND PLAY



dettagli articoli:

KIT lampade LED **con ventola di raffreddamento**

**40000 lumen per
lampada
12V**

CODICE	DESCRIZIONE	VOLT/WATT	LUMEN
OSR9821	H7	12V- 30W	40000
OSR9822	H4	12V- 30W	40000
OSR9815	HB4	12V- 30W	40000
OSR9816	HB3	12V- 30W	40000
OSR9817	H11	12V- 30W	40000
OSR9818	H3	12V- 30W	40000
OSR9819	H1	12V- 30W	40000

KIT LED SPECIFICI PER FARI LENTICOLARI



OSR9981-1	OSR9981-2	OSR9981-3 1 pz.
Kit lampade LED H7	Kit lampade LED HB3 - HB4 - H10	Kit lampade LED H8 - H11

dettagli articoli

Premium cambus **12/24V - 6.000 LUMEN** per Lampada

COPPIA CENTRALINE SUPER CANBUS per tutti i KIT LED

OSR9980-11 1 pz.

COPPIA SUPER CANBUS H7 NO FLASH - WARNING CANCELLER

OSR9980-12 1 pz.

COPPIA SUPER CANBUS H4 NO FLASH - WARNING CANCELLER

OSR9980-13 1 pz.

COPPIA SUPER CANBUS H1 - H3 NO FLASH-WARNING CANCELLER

KIT ADATTATORI PER LAMPADRE LED



OSR9995/20

1 pz.

Kit adattatori lampade LED
Marchio Guidoni.

<p>OSR 9995/1 Coppia adattatori per kit lampade LED H7, Universale. Foro 22mm Audi A3, A4L, BMW Serie S, X5, Buick Regal, Exeolite, Lacross, Mercedes Classe E, ML, Nissan Qashqai, Opel Astra, Renault Master, W New Boro</p>	<p>OSR 9995/2 Coppia adattatori per kit lampade LED H7 Foro 22mm AUDI, BMW, Mercedes, Classe B,C, GLA, GL</p>	<p>OSR 9995/3 Coppia adattatori per kit lampade LED H7, Foro 23 mm Citroen C5, DS4, DS6, Ford Mondeo, Peugeot 508,2008,3008</p>	<p>OSR 9995/4 Coppia adattatori per kit lampade LED H7, Anabbagliante, Foro 24mm Ford Focus, Mondeo, Fiesta</p>	<p>OSR 9995/5 Coppia adattatori per kit lampade LED H1, Anabbagliante Ford Focus</p>	<p>OSR 9995/6 Coppia adattatori per kit lampade LED H7 Hyundai Santa Fe, Qashqai, New Tucson Sonata</p>
<p>OSR 9995/7 Coppia adattatori per kit lampade LED H Hyundai Mistra, Kia New Carens</p>	<p>OSR 9995/8 Coppia adattatori per kit lampade LED H VW Polo, New Tiguan Skoda Octavia MG, GS</p>	<p>OSR 9995/9 Coppia adattatori per kit lampade LED H7, Foro 22mm Mercedes Sprinter, Seat Alhambra 2012 W Golf IV, VII, Scirocco</p>	<p>OSR 9995/10 Coppia adattatori per kit lampade LED H1, Universale, Foro 22mm DongFeng, Fengxing Honda, Odyssey, Cielly, Moto G Eagle, SouthEast, V3 V4 V6</p>	<p>OSR 9995/11 Coppia adattatori per kit lampade LED H7, Mazda 3, Outlander</p>	<p>OSR 9995/12 Coppia adattatori per kit lampade LED H Foro 23mm Alfa Romeo Mito, Audi A6, Ford Kuga, Renault Megane 4, VW Sagitar Passat 3G, Touran</p>
<p>OSR 9995/13 Coppia adattatori per kit lampade LED H7, Anabbagliante W Tiguan, Golf VII, Scirocco, Sharon, Multivan</p>	<p>OSR 9995/14 Coppia adattatori per kit lampade LED H7, Autoalimentazione con spina, Foro 23mm Mercedes Sprinter, Seat A1, Hambra 2012, VW Golf, VII, Sharon, Touran Scirocco, Polo 2013</p>	<p>OSR 9995/15 Coppia adattatori per kit lampade LED H1, Abbagliante Ford Focus, Mondeo, Fiesta</p>	<p>OSR 9995/16 Coppia adattatori per kit lampade LED H7 Fiat Nuova 500 500X, 500L</p>		



OSR9995/1

1 pz.

Coppia adattatori per kit lampade LED **H7**, universale, foro 22mm audi a3, a4l, a6l, bmw serie5, x5, mercedes classe e, ml, nissan qashqai, opel astra, renault master, vw new bora



Marchio Guidoni.



OSR9995/2

1 pz.

Coppia adattatori per kit lampade LED **H7**, foro 22mm, audi, bmw, mercedes classe b, c, gla, gl

Marchio Guidoni.





OSR9995/3 1 pz.

Coppia adattatori per kit lampade LED **H7**, foro 23 mm, citroen c5, ds5, ds6, ford mondeo, peugeot 508, 2008, 3008

Marchio Guidoni.



OSR9995/4 1 pz.

Coppia adattatori per kit lampade LED **H7**, anabbagliante foro 24mm, ford focus mondeo, fiesta.

Marchio Guidoni.



OSR9995/5 1 pz.

Coppia adattatori per kit lampade LED **H1**, anabbagliante ford focus.

Marchio Guidoni.



OSR9995/6 1 pz.

Coppia adattatori per kit lampade LED **H7**, hyundai santa fe, qashqai, new tucson,sonata.

Marchio Guidoni.



OSR9995/7 1 pz.

Coppia adattatori per kit lampade LED **H7**, universale, hunday, kia, new carens

Marchio Guidoni.



OSR9995/8 1 pz.

Coppia adattatori per kit lampade LED **H7**, vw polo, new tigan, skoda octavia, mg gs

Marchio Guidoni.





OSR9995/9 1 pz.

Coppia adattatori per kit lampade LED **H7**, foro 22mm
mercedes sprinter, seat alhambra 2012

Marchio Guidoni.



OSR9995/10 1 pz.

Coppia adattatori per kit lampade LED **H1**, foro 19mm

Marchio Guidoni.



OSR9995/11 1 pz.

Coppia adattatori per kit lampade LED **H7** mazda 3, outlander

Marchio Guidoni.



OSR9995/12 1 pz.

Coppia adattatori per kit lampade LED **H7**, foro 23mm
alfa romeo mito, audi a6, ford Kuga, renault MEGANE 4,
vw agitar, passat 3c, touran

Marchio Guidoni.



OSR9995/13 1 pz.

Coppia adattatori per kit lampade LED **H7**, anabbagliante
vw tiguan, golf VII, scirocco, multivan

Marchio Guidoni.



OSR9995/14 1 pz.

Coppia adattatori per kit lampade LED **H7**, auto-alimentazione
con spina, foro 23mm mercedes Sprinter, seat a1, alhambra
2012, vw golf, vii, sharAn, touran, scirocco, polo 2013
Marchio Guidoni.



7- Lampade LED e xenon



OSR9995/15

1 pz. 

Coppia adattatori per kit lampade LED **H1**, abbaglianti
ford focus mondeo, fiesta

Marchio Guidoni.



OSR9995/16

1 pz. 

Coppia adattatori per kit lampade LED **H7**,
fiat nuova 500, 500x, 500l

Marchio Guidoni.



OSR9995/17

1 pz. 

Coppia adattatori lampade kit led e xenon per trasformazione
da **h4** a **h5**

Marchio Guidoni.

COPPIA DI TAPPI IN GOMMA PER KIT



CODICE	DIAMETRO	CF. 
OSR9991/1	55mm	2PZ.
OSR9991/2	65mm	2PZ.
OSR9991/3	70mm	2PZ.
OSR9991/4	80mm	2PZ.
OSR9991/5	85mm	2PZ.
OSR9991/6	90mm	2PZ.
OSR9991/7	95mm	2PZ.
OSR9991/8	100mm	2PZ.
OSR9991/9	105mm	2PZ.
OSR9991/10	110mm	2PZ.
OSR9991/11	115mm	2PZ.
OSR9991/12	120mm	2PZ.

MOLLETTE DI RITENUTA PER LE LAMPADE



OSR9800-1	H1-1		OSR9802-3	H4-3	
OSR9800-2	H1-2		OSR9803-1	H7-1	
OSR9800-3	H1-3		OSR9803-2	H7-2	
OSR9800-4	H1-4		OSR9803-3	H7-3	
OSR9801	H3		OSR9804	UNIVERSALI SINGOLE	
OSR9802-2	H4-2		OSR9805	UNIVERSALI DOPPIE	

KIT

OSR9806

Kit **12 COPPIE** MOLLETTE DI RITENUTA PER LAMPADE



FARI DA LAVORO LED HIGH POWER



IND8200 1 pz.

Faro LED **63W+10W 12/24V** 9 LED da 7W CREE **100X92X69MM** connettore deutsch

3 funzioni
faro lavoro- luce diurna - luce arancio

6000K IP67-IP69K
Temperatura di lavoro -40°+85°
EMARK



IND8201 1 pz.

Faro LED **60W+10W 12/24V** 6 LED da 10W CREE **245X139.5X91.35MM** connettore deutsch

3 funzioni
faro lavoro- luce diurna - luce arancio

6000K IP67
Temperatura di lavoro -40°+85°

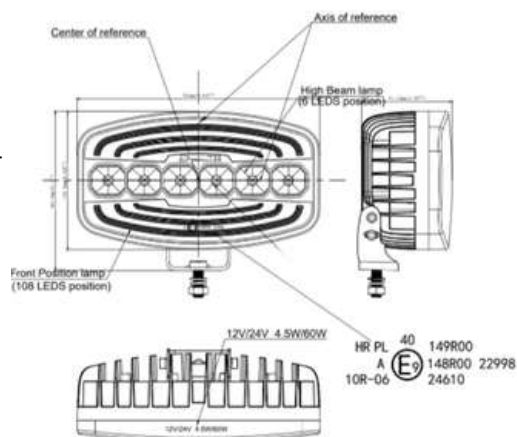

IND8202 1 pz.

Faro LED **80W+10W 12/24V** 8 LED da 7W CREE **155X177X93MM** connettore deutsch

3 funzioni
faro lavoro- luce diurna - luce arancio

6000K IP67-IP69K
Temperatura di lavoro -40°+85°

EMARK

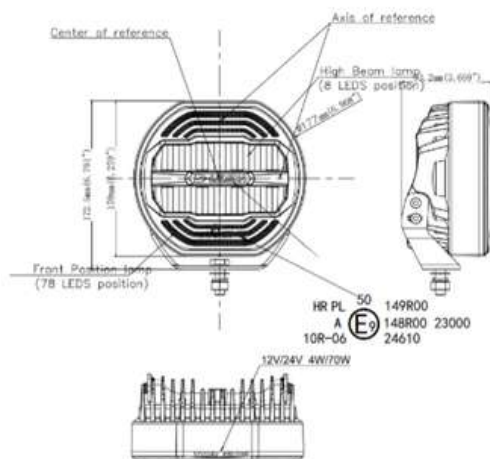

IND8203 1 pz.

Faro LED **160W+10W 12/24V** 8 LED da 20W CREE **204X227X110** connettore deutsch

3 funzioni
faro lavoro- luce diurna - luce arancio

6000K IP67
Temperatura di lavoro -40°+85°

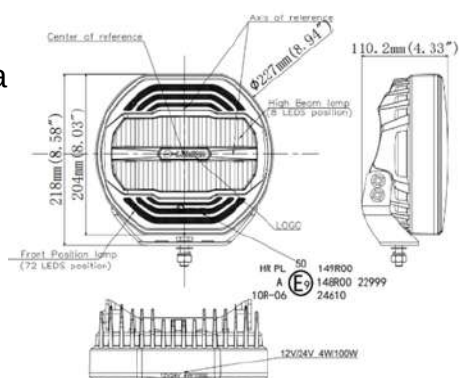



6000K IP67
Temperatura di lavoro
-40+85 ECE R10
connettore deutsch

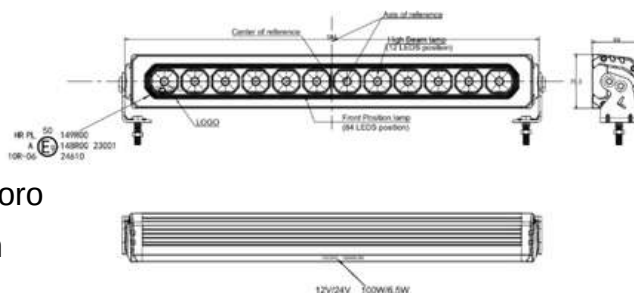

12/24V

[dettagli articoli](#)

CODICE	FUNZIONI	WATT	LUMEN	MISURE	CF.
IND8204	FARO LAVORO, LUCE DIURNA, LUCE	140W	950 LM	584X76X69mm	1PZ.
IND8204-1	FARO LAVORO, LUCE DIURNA, LUCE	220W	15000 LM	813X76X69mm	1PZ.
IND8204-2	FARO LAVORO, LUCE DIURNA, LUCE	280W	18000 LM	1067X76X69mm	1PZ.



IND8264

1 pz.



**CHIP & LED
OSRAM**

Faro lavoro 4 led forma quadrata **12/24V** - 1500 lumen
misure: 7.62 X7.62 CM
IP6K9K

In rapporto alle dimensioni, il più piccolo e potente faro sul mercato.



IND8265

1 pz.



**CHIP & LED
OSRAM**

Faro lavoro 4 LED forma tonda **12/24V**
diametro: 7.62 CM - 1500 lumen- IP6K9K

In rapporto alle dimensioni, il più piccolo e potente faro sul mercato.



IND8267

1 pz.



**CHIP & LED
OSRAM**

Faro lavoro 6 led forma quadrata **12/24V** -
2350 lumen 30W
misure: 9X9CM
IP6K9K



7- Fari da lavoro LED



IND8268

1 pz. 



**CHIP & LED
OSRAM**

Faro lavoro 6 led forma tonda **12/24V** -
2350 lumen **30W**
misure: D. 10,2cm
IP6K9K



IND8269

1 pz. 



**CHIP & LED
OSRAM**

Faro lavoro 16 led forma quadrata **12/24V** - 2350
lumen **48W**
misure: 8.4X8.4X3.3CM
IP6K9K



IND8212

1 pz. 



**CHIP & LED
OSRAM**

Faro da lavoro forma tonda 6 LED osram da 10W
12/24V 5100 LUMEN
Diametro: 130mm
Profondità: 81mm
applicazioni:
Allis 7069614
case A145495
International 131368C92
John deere: RE19079-AR8560



IND8213

1 pz. 



**CHIP & LED
OSRAM**

Faro da lavoro 4 LED osram 40W **12/24V**
3200 LUMEN
misure: 84x84x33mm
IP6K9K



IND8208

1 pz. 

Faro da lavoro forma quadrata 9 led
9-32V 27W
1755 LUMEN
Marchio Guidoni.

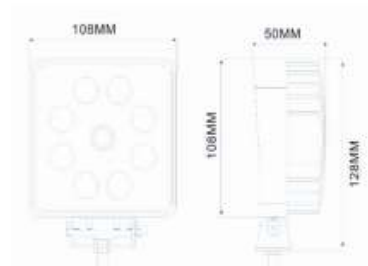



IND8208I 1 pz.

Faro lavoro forma quadrata 9 led,
9/32v, 27W, 1850lumen
con interruttore e maniglia

Marchio Guidoni

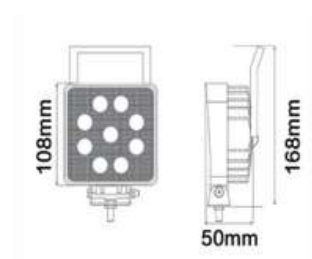

IND8209 1 pz.

Faro da lavoro forma tonda 9 led **9-32V**
27W
diametro: 11 cm, 1755 lumen

Marchio Guidoni.

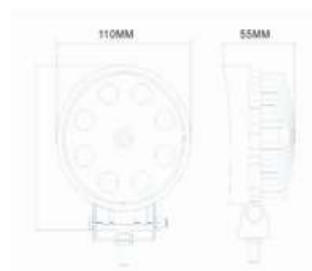

IND8205-16 1 pz.

Faro da lavoro quadrato 16 led, **10/30V,**
32W

Marchio Guidoni

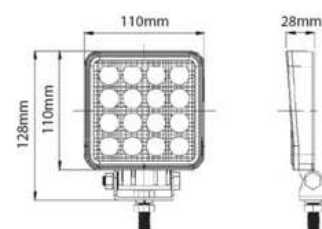

IND8243 1 pz.

Faro da lavoro quadrato 16 led ,

9/32V, 48W,
3600 lumen.

Marchio Guidoni

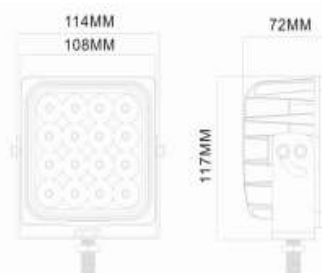

IND8227 IND8227SI 1 pz.

CON SENZA
interruttore interruttore

dettagli articoli:

Faro da lavoro quadrato **12W**
1020 LUMEN
12LED 9-32V IP68
Misure: 76x95x25mm

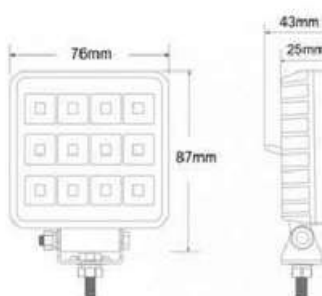

IND8228 IND8228SI 1 pz.

CON interruttore SENZA
interruttore

dettagli articoli:

Faro da lavoro quadrato **16W**
1630LUMEN
16LED 9-32V IP68
Misure: 90x110x30mm

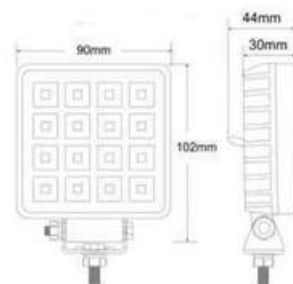

7- Fari da lavoro LED



IND8210 1 pz.

Faro da lavoro quadrato 4 led
9-32V - 10W
misure: 6,6x6,6cm
 760 lumen

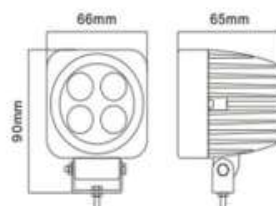

IND8211 1 pz.

Faro da lavoro rettangolare 6 led
9-32V 18w
misure: 11x6cm
 1170 lumen

Marchio Guidoni.

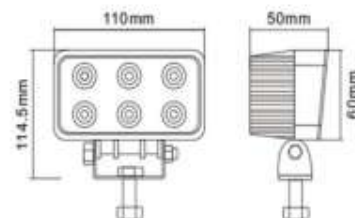

IND8229 1 pz.

Faretto ovale 8 led **9-23V 24W**,
 1560 lumen

Marchio Guidoni.

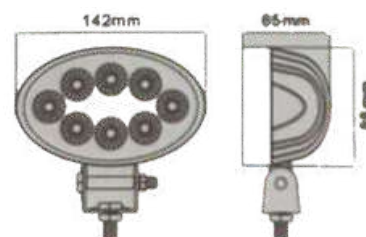

IND8266 1 pz.

Faro tondo 9 LED base palo flessibile 9 LED
10-36V, 27W



IND8236 1 pz.

Faro lavoro LED quadrato base palo flessibile originale vignal.
 Con maniglia e interruttore.
 Doppia ottica, profondità ed espansione.

9-32V
misure: 90x243x58mm
 1000 lumen

Marchio Guidoni.

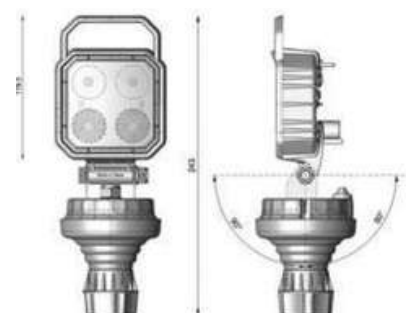

IND8237 1 pz.

Faro lavoro LED tondo da incasso, originale vignal.
 Doppia ottica, profondità espansione.

Diametro **86mm**
 1000 lumen
9-32V
 IP69k

Marchio Guidoni.





IND8238

1 pz.

Faro lavoro LED tondo orientabile multidirezionale originale Vignal. Doppia ottica, profondità espansione.

Diametro **86mm**
1000 lumen
9-32V
IP69k

Marchio Guidoni.

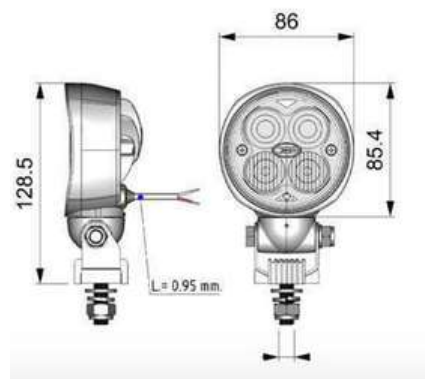

IND8248

1 pz.

Base magnetica per faretto a led, diametro: **65mm**



IND8241

1 pz.

Faro da lavoro rettangolare 6LED, **18W**, 1180 Lumen
misure: 45.2x160x63mm
10-30VDC -6000K -IP68
Marchio Guidoni.



IND8241HP

1 pz.

Faro da lavoro rettangolare 45LED, **45W**, 3600 Lumen
misure: 160X56X50mm
10-30VDC -6000K -IP68
CE/ROhS,E-MARK
Marchio Guidoni.



IND8214

1 pz.

Faro da lavoro quadrato 1 led cree **9-32V 10W**
800 lumen
misure: 70x70mm

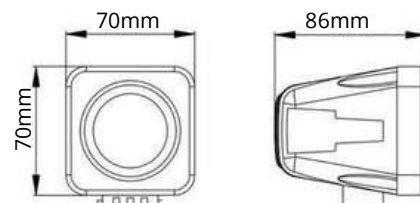

7- Fari da lavoro LED



IND8215

1 pz.

Faro da lavoro tondo 1LED
diametro 8cm,
cree **9-32V 10W**
800 lumen

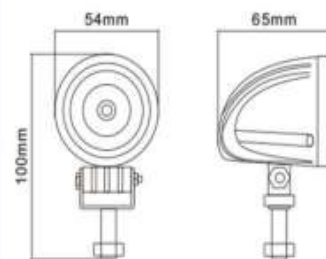

IND8223

12LED da **3W**
(**36w** totali)
9-32V

IND8224

1 pz.

6LED da **3W**
(**12w** totali) **9-32V**

misure: 165x80x68mm

BARRE LED

Marchio Guidoni.

12/24V

dettagli articoli

CODICE	FILA	WATT	LUMEN	MISURE	CF.
IND8225	DOPPIA (figura 1)	120W	720LM	56 cm	1PZ.
IND8226	DOPPIA (figura 1)	240W	1440LM	107 cm	1PZ.
IND8252	SINGOLA (figura 2)	60W	280LM	28 cm	1PZ.
IND8254	SINGOLA (figura 2)	120W	680LM	51 cm	1PZ.
IND8255	SINGOLA (figura 2)	180W	1400LM	76 cm	1PZ.
IND8258	SINGOLA (figura 2)	300W	1400LM	125 cm	1PZ.

BARRE LED HIGH POWER

dettagli articoli:

Barre LED fila singola IP67 con cavo e connettore Deutsch DT

Ottica ad alta profondità

12/24V

CODICE	MISURE	LUMEN	WATT	CF.
IND8294	55.88CM	9500	120W	1PZ.
IND8295	83.8CM	1500	192W	1PZ.
IND8296	106.68CM	18600	240W	1PZ.

IND8297

1 pz.

Faro di potenza
12/24V 3X25W
7000 lumen
Potenza effettiva 72W/ LED
misure: 25.8X7.5 X8.7cm
CHIP-ETI
IP6K9K



FARI LAVORO AMPIO RAGGIO

IND8262 1 pz.



Faro di lavoro a LED ampio raggio 240°
54W LED EPISTAR
grado di impermeabilità: IP67
10-36VDC
temperatura colore: 6000 K~6500 K
temperatura di funzionamento:
-40°C~60°C
lumen: 4000 LM -
fascio SPOT/FLOOD opzionale

materiale: in alluminio pressofuso staffa
in acciaio inossidabile

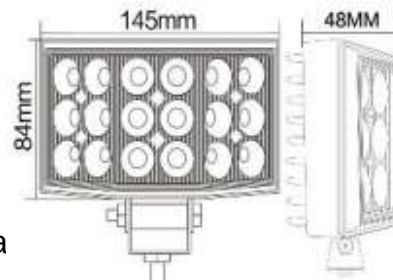

IND8259 1 pz.

Faro da lavoro a LED quadrato ampio raggio 360°

12/24V 40W
9 LED frontali
24 LED laterali
misure: 10.5X10.5X53

applicazioni:
Truck, agricoltura, movimento terra, macchine operatrici

FARI DA INCASSO

IND8250 1 pz.

Faro lavoro LED EPISTAR da incasso tondo
diametro 12cm
- **10-36V**
- 6 LED 18W
- 6000K 1350 lumen

IND8246 1 pz.

Faro lavoro LED EPISTAR da incasso
rettangolare
10-36V
misure: 150X84X40mm
- 6 LED 18W
- 6000K 1350 lumen

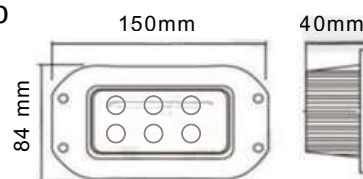

7- Fanali e fari LED



IND8247

1 pz. 

Faro lavoro LED CREE
con cornice rettangolare
10-36V
misure:180X100X57mm
13LED - 39W
- 2925 lumen

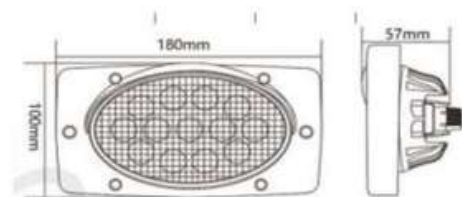

IND8244

1 pz. 

Proiettore LED tondo da incasso, 4 LED
con anello luce diurna DRL, **12/24V**
Marchio Guidoni

PROIETTORI E FARI DA LAVORO ANTERIORI



IND8233

1 pz. 

Coppia di proiettori LED DX+SX **12/24V**

misure: 224X148X108mm

funzioni:

- anabbagliante 30W 3000LUMEN
 - abbagliante 90W 7200LUMEN
 - Posizione/drl 12W 1200 LUMEN
 - Indicatore di direzione ANT+POST 6W 600 LUMEN
- IP67

certificazioni:

CISPR25
CLASSE 4

IND8235-1

1 pz. 



Proiettore LED 12/24V 99W 8000 LUMEN

misure: 167.6 x 107.5 x 80mm IP67
completo di staffe di fissaggio

funzioni:

- anabbagliante 30W
- abbagliante 90W

applicazioni:

NEW HOLLAND
MASSEY FERGUSON
JOHN DEERE



7- Fanali e fari LED



IND8260

1 pz. 

Faro di lavoro a LED con
indicatore di direzione
75W 12-24V EPISTAR
misure: 109x53x136mm

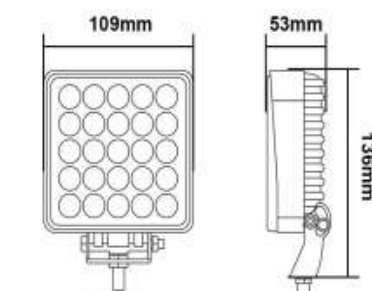

IND8261

1 pz. 

Faro di lavoro a LED ovale
con indicatore di direzione
36W CREE 10-110 VDC
misure: 90x50x140mm

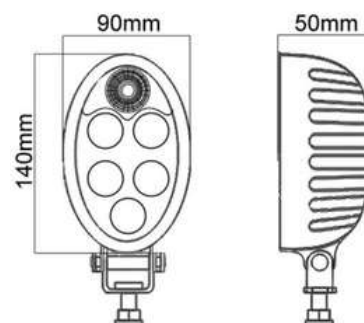

FARI DA LAVORO LED SPOT BLU E LINEA ROSSA PER CARRELLI ELEVATORI



IND8206-80V 1 pz.

Faro da lavoro quadrato 9 LED,
10/110V- 27W

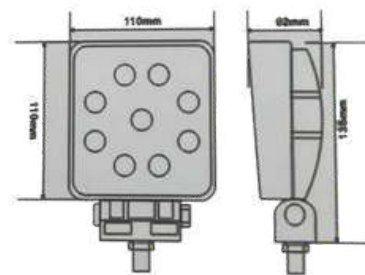

IND8230 1 pz.

Faro da lavoro quadrato LED 10-110V
-40W per carrelli elevatori,
3200 lumen

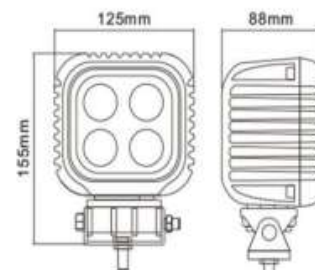

IND8221 1 pz.

Faro da lavoro led e spot **blu**
operanti a 10-110V per carrelli
elevatori.

Marchio Guidoni.

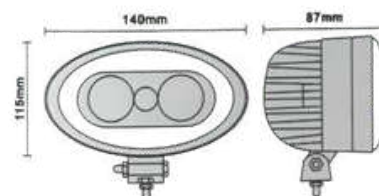

IND8222 1 pz.

Faro da lavoro led e spot **blu**
modello economico, operativo a
10-110V , per carrelli elevatori.

Marchio Guidoni.

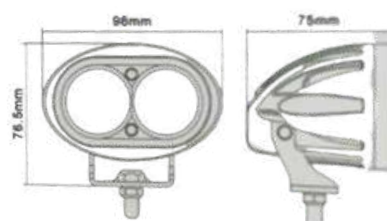

IND8220 1 pz.

Faro da lavoro LED 10-110V
linea **rossa** per carrelli elevatori.

Marchio Guidoni.



7- Lampeggianti e multiflash LED



IND8220T

1 pz.

Faro LED linea **rossa**
forma rettangolare per carrelli
elevatori.

10-110V -30W,
working life 30.000 ore

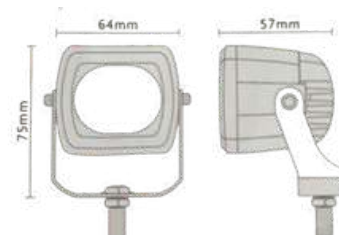

IND8220Q

1 pz.

Faro LED linea **rossa**
forma quadrata per carrelli elevatori.

10-110V , 30W
working life 30.000 ore

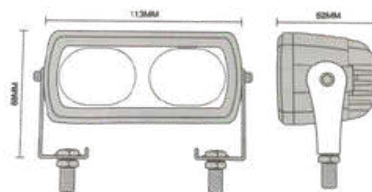

LAMPEGGIANTI MULTIFLASH ENTRY LEVEL

18 TIPI DI LAMPEGGIO SINCRONIZZABILI

LAMPEGGIANTI 3 LED

CODICE	MISURE	VOLT	N.LED	COLORE	FISSAGGIO	CF.
IND8332R	9,3X82,5X30mm	12/24V	3	ROSSO	a vite con adesivo	1PZ.
IND8332BI	9,3X82,5X30mm	12/24V	3	BIANCO	a vite con adesivo	1PZ.
IND8332	9,3X82,5X30mm	12/24V	3	ARANCIONE	a vite con adesivo	1PZ.
IND8332BL	9,3X82,5X30mm	12/24V	3	BLU	a vite con adesivo	1PZ.

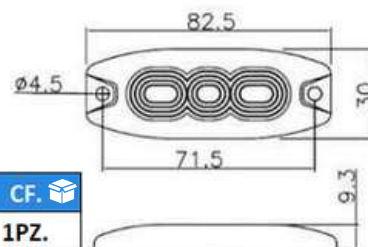

*IND 8332BL FILO DEDICATO PER LUCE DI CROCIERA



LAMPEGGIANTI 4 LED

CODICE	MISURE	VOLT	N° LED	COLORE	FISSAGGIO	CF.
IND8334R	8,3X98,5X30mm	12/24V	4	ROSSO	a vite con adesivo	1PZ.
IND8334BI	8,3X98,5X30mm	12/24V	4	BIANCO	a vite con adesivo	1PZ.
IND8334	8,3X98,5X30mm	12/24V	4	ARANCIONE	a vite con adesivo	1PZ.
IND8334BL	8,3X98,5X30mm	12/24V	4	BLU	a vite con adesivo	1PZ.
IND8334BIF	8,3X98,5X30mm	12/24V	4	BIANCO fisso	a vite con adesivo	1PZ.

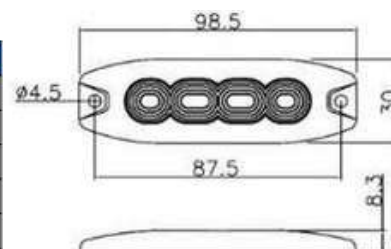

*IND 8334BL FILO DEDICATO PER LUCE DI CROCIERA



7- Lampeggianti e multiflash LED

LAMPEGGIANTI 6 LED

CODICE	MISURE	VOLT	N° LED	COLORE	FISSAGGIO	CF. 
IND8335R	7,3X130,5X30mm	12/24V	6	ROSSO	a vite con adesivo	1PZ.
IND8335BI	7,3X130,5X30mm	12/24V	6	BIANCO	a vite con adesivo	1PZ.
IND8335	7,3X130,5X30mm	12/24V	6	ARANCIONE	a vite con adesivo	1PZ.
IND8335BL	7,3X130,5X30mm	12/24V	6	BLU	a vite con adesivo	1PZ.
IND8335BIF	7,3X130,5X30mm	12/24V	6	BIANCO fisso	a vite con adesivo	1PZ.

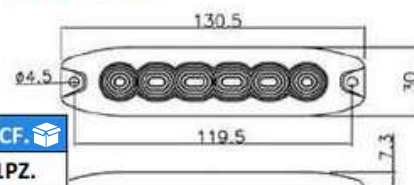

*IND 8335BL FILO DEDICATO PER LUCE DI CROCIERA



LAMPEGGIANTI 24 LED

CODICE	MISURE	VOLT	N.LED	COLORE	FISSAGGIO	CF. 
IND8370BL	130X96mm	12/24V	24	BLU	con adesivo 3M	1PZ.
IND8370	130X96mm	12/24V	24	ARANCIONE	con adesivo 3M	1PZ.



MULTIFLASH TOP QUALITY

IND8910B

COLORE BLU

dettagli articoli:

Multiflash 3 LED 12/24

con luce di crociera

misure: 82X30X11mm

19 tipi di lampeggio con cornice fissaggio a vite

IP69K

-omologazione ECE, R10, R65 - SAES95

IND8910A

COLORE ARANCIO

1 pz. 

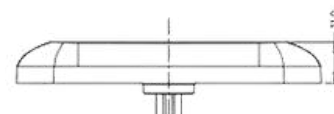
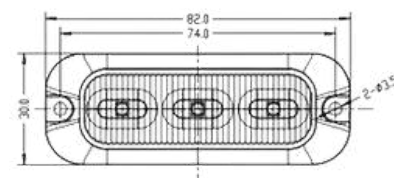

IND8911B

COLORE BLU

dettagli articoli:

Multiflash 4 LED 12/24V

19 tipi di lampeggio con cornice fissaggio a vite

misure: 98x30x11 mm

-omologazione ECE, R10, R65 - SAES95

IND8911A

COLORE ARANCIO

1 pz. 

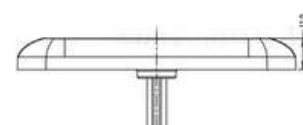
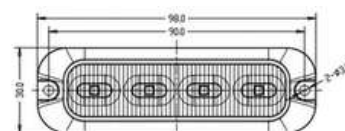

7- Lampeggianti e multiflash LED

IND8912B

COLORE BLU

IND8912A

COLORE ARANCIO

1 pz. 



Multiflash 6 LED 12/24
con luce di crociera

misure: 130X30X11

19 tipi di lampeggio con cornice fissaggio a vite

IP69K -

-omologazione **ECE, R10, R65 - SAES95**

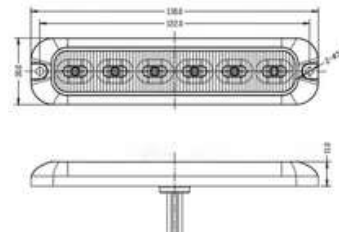

IND8914

1 pz. 

Portatarga con 4 multiflash IND8912B

misure: 537X174.5X41mm

IP69K

CE,UKCA,ECE R10,R65 CLASS 2, SAEJ595 CLASS1



IND8915B

1 pz. 

Multiflash 12 LED da 3W 12/24 **BLU** con luce di crociera

misure:100X36X11.9

12 tipi di lampeggio

base in alluminio e lenti in policarbonato

IP69K - ECE R10 R65 - SAEJ595



MULTIFLASH FLESSIBILE IN SILICONE

IND8373B

COLORE BLU

IND8373A

COLORE ARANCIO

1 pz. 



dettagli articoli:

Un' efficace resistenza a gli urti alla corrosione . Può piegarsi all'indietro fino a 30°. Migliore design anti ingiallimento e antiossidante delle lenti rispetto a quelle tradizionali. Montaggio con adesivo 3M o montaggio a vite.

Misure:112.8x26.2x10.9

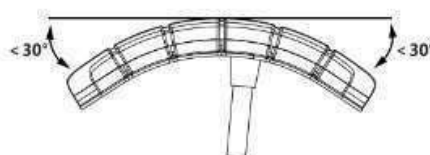
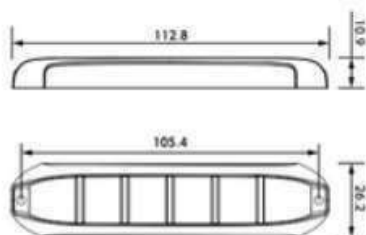

Max 30° angle from center



No Twisting



No Pulling



7- Lampeggianti e multiflash LED



IND8360B
COLORE BLU

IND8360A
COLORE ARANCIO

1 pz.

dettagli articoli:

4 LED
misure: 130X40X11mm
IP67/IP69K
14 tipi di lampeggio
pieghevole fino a 30°
fissaggio a vite o con adesivo 3M
ECE R10 ECE R65, SEJ595

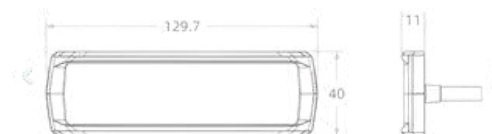

IND8361B
COLORE BLU

IND8361A
COLORE ARANCIO

1 pz.

dettagli articoli:

6 LED
misure: 130X25X11mm
IP67/IP69K
14 tipi di lampeggio
pieghevole fino a 30°
fissaggio a vite o con adesivo 3M
ECE R10 ECE R65, SEJ595

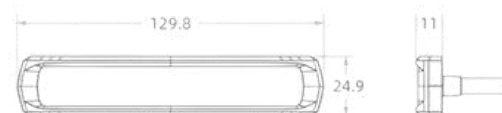

MULTIFLASH DA INTERNO PER PARABREZZA



IND8368
COLORE BLU

IND8367
COLORE ARANCIO

1 pz.

dettagli articoli:

- due moduli **30W** alta luminosità
- **12V** 22 lampeggi programmabili
adatto per parabrezza anteriore e posteriore
fissaggio a ventosa
misure: 247X141X83

IND8367-1

1 pz.

Multiflash da interno per parabrezza
12V **arancio** 1 modulo

6X4W con cavo di 3mt con spina accendisigari
19 lampeggi
fissaggio a ventosa
153.7X37.6X103.5
ECE R10, CE, ECE R65 CLASSE 2,
SAJE 595 CLASSE 1

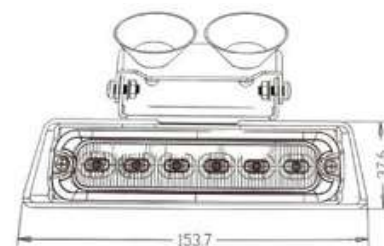

7- Lampeggianti e multiflash LED

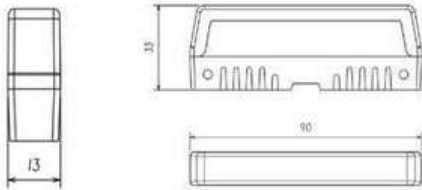

IND8374B
COLORE BLU

IND8374A
COLORE ARANCIO

1 pz.

dettagli articoli:

- tensione: **10-30V DC**
- 8LED ampia visibilità
- potenza **12X3W 18X3W**
- IP IP67
- ECE R65 R10
- diffusione luce 180° wide
- montaggio a superficie, montaggio su staffa
- misure **90X33X13mm**
- omologazione **R65 R10**
- adatto per griglie frontali
- 20 tipi di lampeggio cruise (luce di crociera) + regolazione intensità (dimmer)



IND8369 1 pz.

Spot multi flash led dc **10/30V** - colore **BLU**
con cornice e fissaggio a vite

IND8364
COLORE BLU

IND8364A
COLORE ARANCIO

1 pz.



Spot multiflash LED
12/24V
con cornice fissaggio a vite
12 tipi di lampeggio
diametro: 36MM - altezza: 31mm
Omologazioni: NR65, XA1, R10

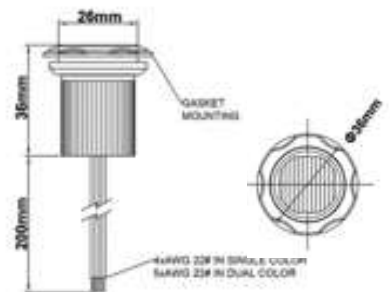

IND8363B
COLORE BLU

IND8363A
COLORE ARANCIO

1 pz.

multiflash 12/24V - 4X3W LED
fissaggio a vite
12 tipi di lampeggio
misure: 74X55X142MM
omologazione: R65, R10

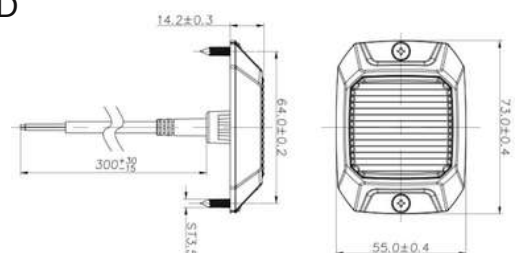

MULTIFLASH PIÙ FARO LAVORO



IND8372B
COLORE BLU

IND8372A
COLORE ARANCIO

1 pz. 

dettagli articoli:

Multiflash più faro lavoro
un'efficace resistenza agli urti e alla corrosione.
Inclinazione di 25°
9 tipi di lampeggio senza lunetta
misure: 45X45X19mm

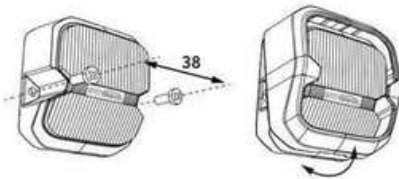

IND8366 1 pz. 

Multiflash **BLU** 12/24 V +faro lavoro **BIANCO**
misure: 180X105X31

La luce può coprire 180°

IP 67

temperatura di esercizio -40° -> + 70°

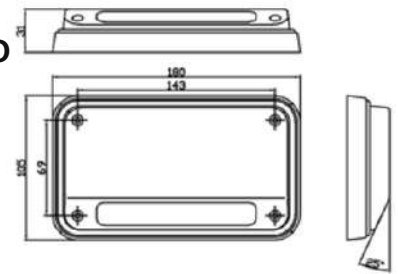

IND8916B 1 pz. 

Plafoniera più multiflash 12/24V **blu** con luce crociera

misure: 179.7x60.9x28mm

3000 lumen - IP69K

faro lavoro 6 LED da 4W

omologazioni:

SAE, ECE, R65-R10-R148



STRISCIA LED FLESSIBILE

IND8375-34 1 pz. 

Striscia LED flessibile **12/24V** colore **arancione**
con movimento luce dinamica.

misure : 34cm

applicazioni:

planton di stazionamento di veicoli industriali, gru,
macchine operatrici.



FARI LED LAMPEGGIANTI

IND8371A **IND8371R** **IND8371B** 1 pz. 

COLORE **COLORE** **COLORE**
ARANCIO **ROSSO** **BLU**



dettagli articoli:

Faro LED EPISTAR
lampeggiante quadrato

9-32V, 5 LED, 15W

misure: 99x72x42mm

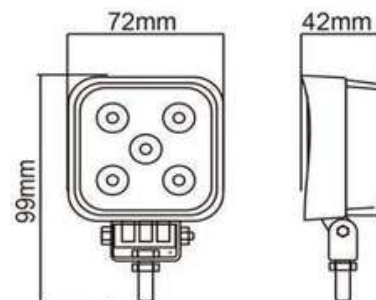

LAMPEGGIANTI PER CARRELLI ELEVATORI



IND8346 1 pz. 

Lampeggiante LED **arancione** a base tonda per applicazioni industriali
12-110V
misure:97x58x130mm

Marchio Guidoni.

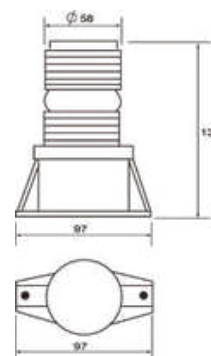

IND8347 1 pz. 

Protezione di sicurezza in acciaio inox a base tonda per lampeggianti LED e xenon per IND8346

Marchio Guidoni.



IND8305L 1 pz. 

Lampeggiante LED **12-110V**,
arancione, base piana
potenza **4W**, 117 lumen
misure:130x93x85mm

Marchio Guidoni.

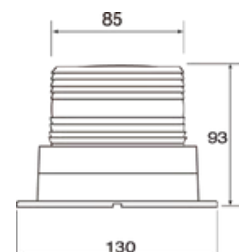

IND8306 1 pz. 

Protezione di sicurezza in acciaio inox a base tonda per lampeggianti LED e xenon per IND8305L

Marchio Guidoni.

7- Lampeggianti e multiflash LED



IND8348

1 pz.

Lampeggiante LED con avvisatore acustico retromarcia integrato colore **arancione**, buzzer integrato, **12-110V**, 5 tipi di lampeggio omologato **R65-R10**
misure: altezza 89mm diametro 130mm

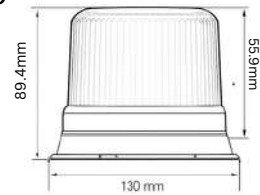

omologazioni:

R65-R10



IND8349

1 pz.

Lampeggiante LED base palo colore **arancione** **12/110V** per carrelli elevatori 5 tipi di lampeggio
misure: altezza 153mm diametro 101mm

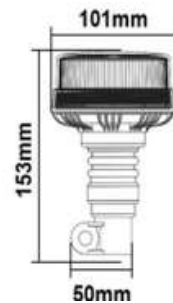

omologazioni:

ECE, R65, R10

LAMPEGGIANTI LED OMOLOGATI



IND8315

1 pz.

Lampeggiante venus LED base piana **12/24V**, colore **arancione**
misure:146x127mm

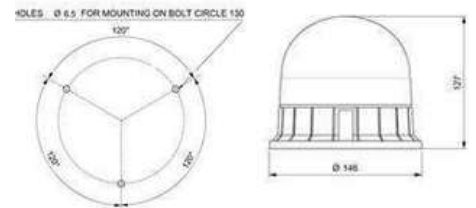

IND8316

1 pz.

Lampeggiante venus LED base palo **12/24V**, colore **arancione**
misure:128x172mm



IND8317

1 pz.

Lampeggiante venus LED magnetico **12/24V**, colore **arancione**
misure:146x135mm

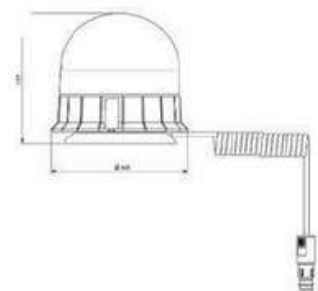

Marchio Guidoni.



7- Lampeggianti e multflash LED



IND8336

COLORE BLU

con luce di crociera

IND8337

COLORE ARANCIO

1 pz.

dettagli articoli:

Lampeggiante LED base piana **10-30V**

22 Modelli di flash selettivi integrati, inclusi 5 modelli di rotazione simulati il nuovo design "lente reflex" garantisce la massima intensità e luminosità del LED

Adatto a tutti i tipi di veicoli per la sicurezza stradale.

omologazioni:

SAE, ECE R65, R10

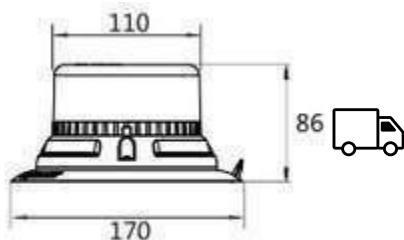

IND8338

1 pz.

Lampeggiante LED magnetico colore **arancio** a **12-24V** con 6 funzioni di lampeggiamento.

Marchio Guidoni.

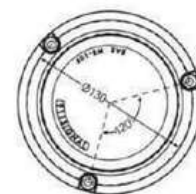
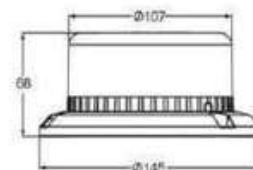

IND8340

1 pz.

Lampeggiante LED base palo colore **arancio** a **10-30V**
omologazioni:

SAE, ECE R65 e R10

Marchio Guidoni.

D. 10,5 CM

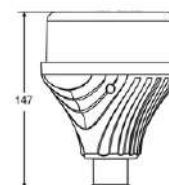

IND8321

COLORE BLU

con luce di crociera

IND8320

COLORE ARANCIO

1 pz.

dettagli articoli:

Lampeggianti LED base piana con luce di crociera a **12-24V**
IP65, Classe 1 potenza LED **54W**

omologazioni: ECE, R65

Marchio Guidoni.

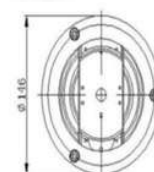

7- Lampeggianti e multiflash LED



IND8322

1 pz. 

Lampeggiante LED magnetico
colore **arancio** con accendisigari e
luce di crociera
12-24V IP65, Classe 1 potenza LED
54W
misure:150x180mm

omologazioni:

ECE, R65

Marchio Guidoni.



IND8341M

COLORE BLU

IND8342M

COLORE ARANCIO

1 pz. 

dettagli articoli:

Lampeggianti LED magnetici
a **10-30V 18x3W** 240km/h
misure: 110X50mm
10 funzioni di lampeggiamento
con spinotto accendisigari con cavo di **2.5mt**

omologazioni:

R65, TA2, TB2, CEC, R10



IND8341P

1 pz. 

Lampeggiante LED base palo
colore **blu**
a **10-30V 18x3W** 240km/h
misure:110X50mm
10 funzioni di lampeggiamento
con spinotto accendisigari con cavo di **2.5mt**

omologazioni:

R65, TA2, TB2, CEC, R10



IND8318

1 pz. 

Lampeggiante LED magnetico
colore **arancio**
12/24V ricaricabile
con spinotto accendisigari
misure: altezza 98mm diametro 123mm

omologazioni:

R65-R10



7- Lampeggianti e multiflash LED



IND8344

1 pz. 

Lampeggiante LED Taurus base piana
colore **blu**
10/30V in policarbonato
misure: altezza 158mm diametro 146mm

omologazioni:

R10

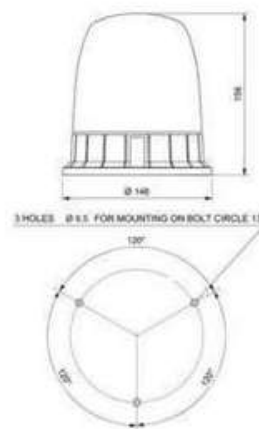

SUPPORTI PER LAMPEGGIANTI BASE PALO



IND8307

1 pz. 

Supporto per lampeggianti base palo da avvitare
Marchio Guidoni.



IND8308

1 pz. 

Supporto per lampeggianti base palo da saldare
Marchio Guidoni.



IND8310

1 pz. 

Supporto per lampeggianti base palo con staffa centrale
Marchio Guidoni.



IND8311

1 pz. 

Supporto per lampeggianti base palo con staffa laterale
Marchio Guidoni.

SPINOTTI PER LAMPEGGIANTI



IND8309

1 pz. 

Spinotto per lampeggianti
Marchio Guidoni.



7- Barre LED lampeggianti

MINI BARRE LED



12/24V

CODICE	COLORE	MISURE	FISSAGGIO	FUNZIONI DI LAMPEGGIO	CF.
IND8357	ARANCIO	248X172X37mm	MAGNETICO	22 FUNZIONI	1PZ.
IND8356	ARANCIO	248X172X37mm	A VITE	22 FUNZIONI	1PZ.
IND8355	BLU	248X172X37mm	A VITE	22 FUNZIONI	1PZ.

BARRE LAMPEGGIANTE A LED

12/24V



caratteristiche

Con luce di crociera
cavo 150cm
17 tipi di lampeggio IP67

certificazioni

SAE J845 CAT.13 ECE R65
CLASSE2 ECE R10

CODICE	COLORE	MISURE	CF.
IND8376A	ARANCIO	603X281X48mm	1PZ.
IND8380A	ARANCIO	907X281X48mm	1PZ.
IND8380B	BLU	907X281X48mm	1PZ.
IND8381A	ARANCIO	1211X281X48mm	1PZ.
IND8381B	BLU	1211X281X48mm	1PZ.
IND8382A	ARANCIO	1515X281X48mm	1PZ.
IND8382B	BLU	1515X281X48mm	1PZ.
IND8383A	ARANCIO	1819X281X48mm	1PZ.
IND8383B	BLU	1819X281X48mm	1PZ.

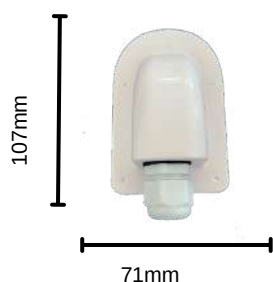
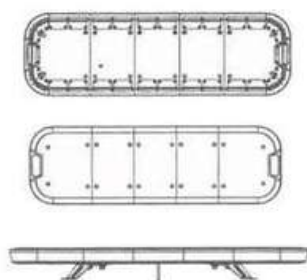

IND8377

1 pz.

Accessorio passaparete
1VIA stagno IP67

misure:44x71x107mm (HxWxP)

Adatto per montaggio su tutti i tipi di barre e lampeggianti LED

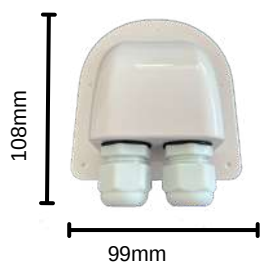

IND8378

1 pz.

Accessorio passaparete
2VIE stagno IP67

misure:44x99x108mm (HxWxP)

Adatto per montaggio su tutti i tipi di barre e lampeggianti LED



TASTIERINI E CONTROLLER



IND8379-1 1 pz.

12/24V

Controller per barre a led **12/24V**
4 funzioni, interruttori o pulsanti, adesivo 3M

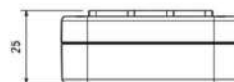
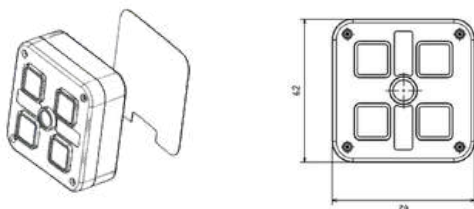

IND8379-1B 1 pz.

Supporto per **IND8379-1**
per fissaggio a vite o con adesivo 3M



IND8379-1B 1 pz.

Supporto per **IND8379-1**
per fissaggio a ventosa



Y6864 1 pz.

Tastierino di controllo 6 tasti
12/24V

massima potenza: **12V 1200W 24V 600W**
misure: 92x66x15.9MM

Il kit comprende:

80 simboli adesivi

accessori per l'installazione e fusibile di
potenza ripristinabile



Circuit 1	Circuit 2	Circuit 3
5A	10A	10A
Circuit 4	Circuit 5	Circuit 6
20A	20A	30A



Y7116 1 pz.

Tastierino di controllo 8 tasti RGB
12/24V

massima potenza: **12V - 1440W - 24V 720W**
massimo amperaggio: 60A

temperatura di utilizzo: -40° +85°

misure: 135x66x23mm

Il kit comprende:

140 simboli adesivi

accessori per l'installazione e fusibile di potenza
ripristinabile.



PLAFONIERE LED



IND8559

1 pz.

Mini plafoniera 3 LED SMD **12-24V**
misure: 84X24X10mm

Marchio Guidoni.



IND8578

SENZA
INTERRUTTORE

IND8579

CON INTERRUTTORE
TOUCH

1 pz.

dettagli articoli

Plafoniera LED tonda **12/24V**

Diametro 130mm

1080 LUMEN IP67 adatta per isothermici -40°+65°

ECE R10



IND8552

1 pz.

Plafoniera LED tonda **12/24V**

Diametro 160mm

IP67 1200, LUMEN, R10

da incasso per furgoni isothermici

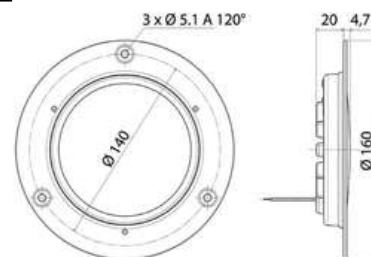

IND8575-220

SENZA
INTERRUTTORE

IND8575-220P

CON INTERRUTTORE
TOUCH

1 pz.

dettagli articoli

Plafoniera LED forma rettangolare **12/24V**

misure: 220X75X11mm

860 LUMEN

4500K IP67

adatta per isothermici -40°+65°

ECE R10

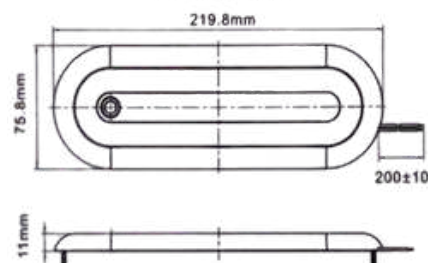
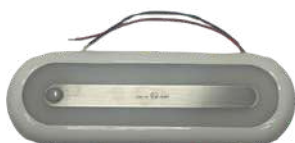

7- Plafoniere LED



IND8585

1 pz. 

Plafoniere LED quadrata,
misure: 124x124mm,

adatta per isothermici,
12/24V 500 lumen,
 IP69K R-10

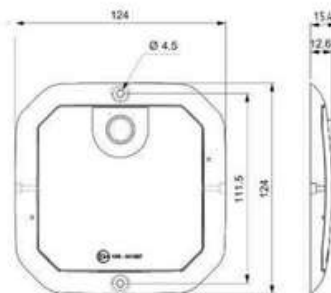

dettaglio articoli

Plafoniere LED rettangolare

adatta per isothermici -40°+65° **IP67 4500K**

ECE R10

12/24V



CODICE	INTERRUTTORE	LUMEN	MISURE	CF. 
IND8574-175	senza PIR	280LM	175X54X11mm	1PZ.
IND8574-300	senza PIR	680LM	300X54X11mm	1PZ.
IND8574-500	senza PIR	1400LM	500X54X11mm	1PZ.
IND8574-500P	con PIR	1400LM	500X54X11mm	1PZ.

PLAFONIERE PER ILLUMINAZIONE INTERNA THIN LINEAR

dettaglio articoli

Plafoniere thin linear componibile e regolabile.
 Luce bianca, fredda. **12V o 24V**

Marchio Guidoni.



CODICE	MISURE	VOLT	N°LED	CF. 
IND8538	300x34mm	12V	42	1PZ.
IND8539	500x34mm	12V	56	1PZ.
IND8540	1000x34mm	12V	112	1PZ.
IND8546	300x34mm	24V	42	1PZ.
IND8547	500x34mm	24V	56	1PZ.
IND8548	1000x34mm	24V	112	1PZ.

IND8541

1 pz. 

Connettore di uscita per plafoniere.

Marchio Guidoni.



IND8542

1 pz. 

Interruttore per plafoniere thin linear.

Marchio Guidoni.



7- Plafoniere LED



IND8543

1 pz. 

Giunzione per plafoniere thin linear.
Marchio Guidoni.



IND8544

1 pz. 

Sensore PIR regolabile per plafoniere thin linear.
Marchio Guidoni.



IND8545

1 pz. 

Interruttore generale per plafoniere thin linear.
Marchio Guidoni.

PLAFONIERE LED CON INTERRUTTORE

dettagli articoli

Plafoniere LED con interruttore, in alluminio con lente in policarbonato, colore bianco freddo
12/24V

Marchio Guidoni.



CODICE	LED	LUMEN	MISURE	CF. 
IND8534	18 LED	380	266X28X13,5mm	1PZ.
IND8536	81 LED	1620	970X28X13,5mm	1PZ.
IND8537	45 LED	900	570X28X13,5mm	1PZ.

LEGGI MAPPA FLESSIBILI



IND8553

1 pz. 

Leggi mappa flessibile LED, 192 lumen, **12V**, 325mm
Marchio Guidoni.



PLAFONIERE PER ILLUMINAZIONE ESTERNA MONTAGGIO ANGOLARE

SCENE
LIGHT 45°

IND8590

1 pz. 



Plafoniera LED montaggio angolare **12/24V**

-**misure:** 230x41x29mm

-IP67

-6 LED da 3W

applicazione ambulanze vigili del fuoco

schema tecnico figura 9



dettagli articoli



CODICE	SCHEMA TECNICO	WATT	LUMEN	COLORE	MISURE	CF. 
IND8591B	Figura 1	9W	750LM	BIANCO	129X68X65mm	1PZ.
IND8591N	Figura 1	9W	750LM	NERO	129X68X65mm	1PZ.
IND8592B	Figura 2	18W	1450LM	BIANCO	229X68X65mm	1PZ.
IND8592N	Figura 2	18W	1450LM	NERO	229X68X65mm	1PZ.
IND8593B	Figura 3	27W	2250LM	BIANCO	329X68X65mm	1PZ.
IND8593N	Figura 3	27W	2250LM	NERO	329X68X65mm	1PZ.
IND8594B	Figura 4	36W	3200LM	BIANCO	451X68X50.5mm	1PZ.
IND8594N	Figura 4	36W	3200LM	NERO	451X68X50.5mm	1PZ.
IND8595B	Figura 5	54W	4300LM	BIANCO	569X68X65mm	1PZ.
IND8595N	Figura 5	54W	4300LM	NERO	569X68X65mm	1PZ.



dettagli articoli

CODICE	SCHEMA TECNICO	WATT	LUMEN	COLORE	MISURE	CF. 
IND8596B	Figura 6	18W	1450LM	BIANCO	230X58X47mm	1PZ.
IND8596N	Figura 6	18W	1450LM	NERO	390X58X47mm	1PZ.
IND8597B	Figura 7	30W	2500LM	BIANCO	311X58X47mm	1PZ.
IND8597N	Figura 7	30W	2500LM	NERO	311X58X47mm	1PZ.
IND8598B	Figura 8	42W	3500LM	BIANCO	390X58X47mm	1PZ.
IND8598N	Figura 8	42W	3500LM	NERO	390X58X47mm	1PZ.

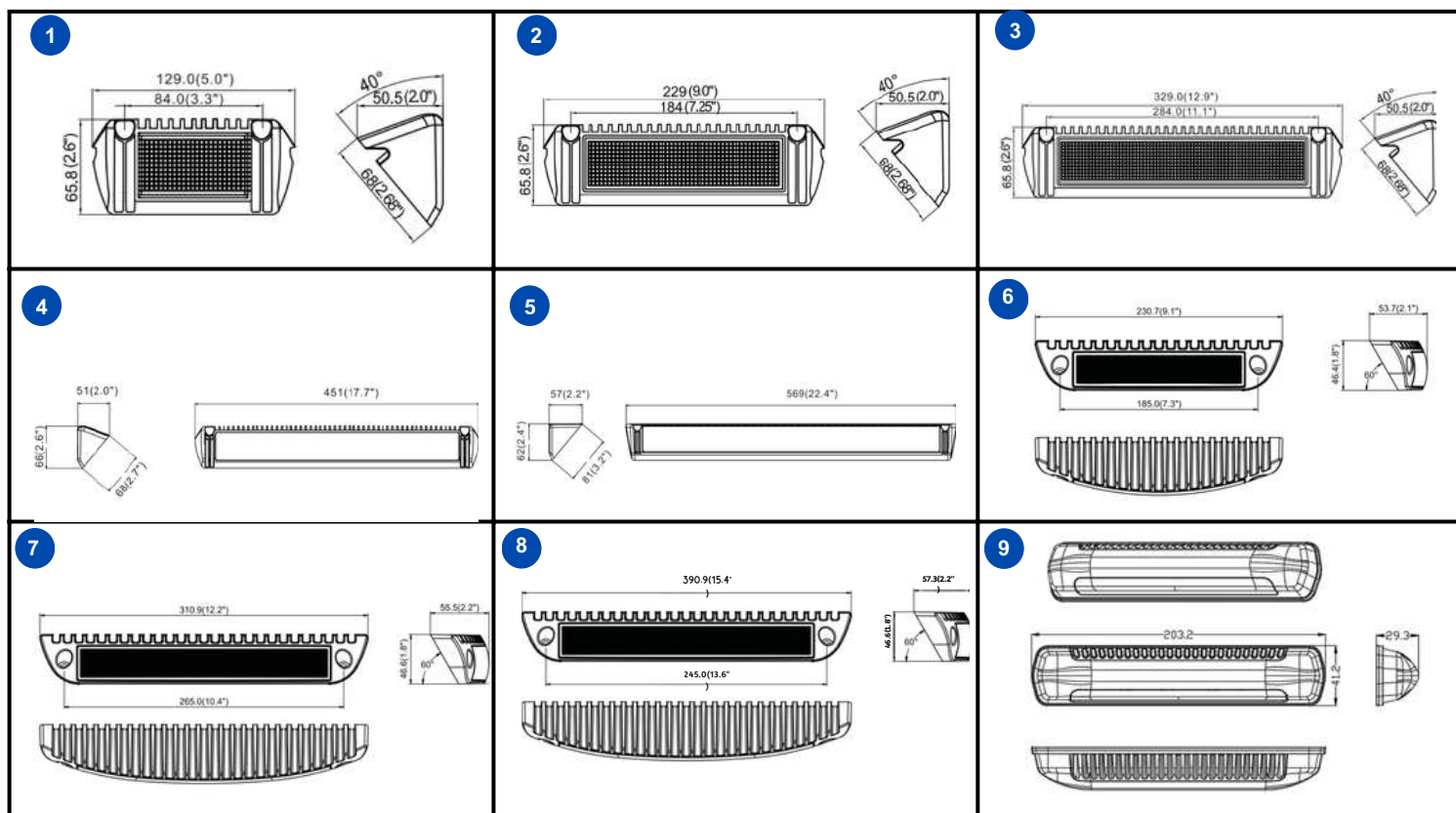

IND8251

1 pz.

Plafoniera LED colore nero
18W, 1450 LUMEN
misure: 132.9X43.9mm

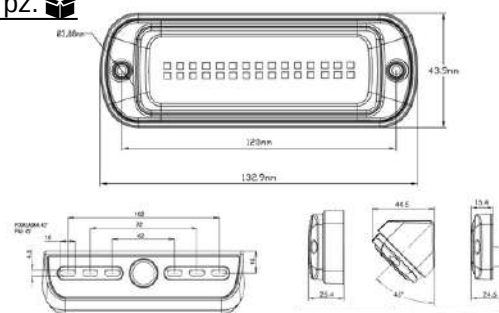

IND8589

1 pz.

Plafoniera LED colore bianco 12/24V 40W
2500LUMEN 6000K fissaggio angolare
misure: 251X38X53
OMOLOGAZIONI R10



7- Strisce LED

SERIE STRISCE A LED 10MM

dettagli articoli

Striscia LED continua adesiva, vari colori, 10mm, 528 LED/mt, 15W/mt 1450 lumen/mt - IP66 tagliabile ogni 22.7mm, **Adesivo 3M**

CODICE	VOLT	COLORE	CF. 
OSR9992-1	12V	BIANCO	5MT
OSR9992-1BL	12V	BLU	5MT
OSR9992-1-24	24V	BIANCO	5MT

Connettori per strisce luce continua LED

OSR9993-1 **OSR9993-2** **OSR9993-3** 5pz. 

Connettore di giunzione

Connettore di alimentazione
misura: 15cm

Connettore di giunzione
misura: 15cm



SERIE STRISCE A LED 5 MM

dettagli articoli

Striscia LED continua adesiva, 5mm **400LED/mt, 14W/mt**, tagliabile ogni 22,7mm **adesivo 3M** - IP66.

La particolarità di questa luce LED continua è l'altezza della striscia che rende possibile la sua applicazione negli spazi più ristretti.

CODICE	VOLT	COLORE	CF. 
OSR9992BL	12V	BLU	5MT
OSR9992R	12V	ROSSO	5MT
OSR9992V	12V	VERDE	5MT
OSR9992	12V	BIANCO	5MT



STRISCE LED LUCE CONTINUA

Materiale silconico

480LED/MT

6000K

Adesivo 3M - IP67 luce frontale

12/24V

CODICE	VOLT	COLORE	MISURE	CF. 
OSR9856-12BI	12V	BIANCO	4x10mm	5mt.
OSR9856-12BL	12V	BLU	4x10mm	5mt.
OSR9856-12V	12V	VERDE	4x10mm	5mt.
OSR9856-12R	12V	ROSSO	4x10mm	5mt.
OSR9856-24BI	24V	BIANCO	4x10mm	5mt.
OSR9856-24BL	24V	BLU	4x10mm	5mt.
OSR9856-24V	24V	VERDE	4x10mm	5mt.
OSR9856-24R	24V	ROSSO	4x10mm	5mt.



ALIMENTATORI

OSR9865

1 pz. 



Alimentatore da 0 -> 30 VDC massimo **5AMP** per strisce di luce continua.
Consente la regolazione d'intensità luminosa (luce soffusa) delle strisce LED.
Utilizzabile anche per strisce LED o dispositivi a **12V** su impianti a **24V**

Marchio Guidoni.

OSR9866

1 pz. 



Elevatore di tensione da 5 -> 30 VDC
12/24V
massimo **3AMP**

OSR9867

1 pz. 



Potenzimetro elettronico **3AMP**
12/24V può regolare l'intensità luminosa o il numero di giri sui motorini in C.C

FANALINI INGOMBRO LED CON CAVO 500 MM



Fanali LED **12-24V** di ingombro, con cavo da 500mm.

Ottima qualità e facile montaggio.

Marchio Guidoni.

CODICE	POSIZIONE	CARATTERISTICA	COLORE	CF. 
IND8469	Laterale	Cavo con staffa	ARANCIO	1PZ.
IND8470	Laterale	Cavo	ROSSO	1PZ.
IND8471	Laterale	Cavo	BIANCO	1PZ.

7- Fanalini ingombro LED

FANALINI DI POSIZIONE CON CAVO 500 MM



Fanali LED **12-24V** di posizione, con cavo da **500mm**.
ottima qualità e facile montaggio.

Marchio Guidoni.

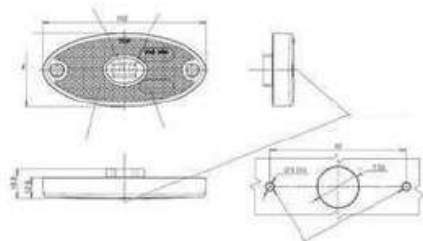

CODICE	POSIZIONE	CARATTERISTICA	COLORE	CF. 
IND8472	Laterale	Cavo 500mm click-in con staffa	ARANCIO	1PZ.
IND8472E	Laterale	SENZA click-in con staffa	ARANCIO	1PZ.
IND8473	Laterale	Cavo 500mm click-in	BIANCO	1PZ.
IND8474	Laterale	Cavo 500mm click-in	ROSSO	1PZ.

FANALINI DI INGOMBRO LED CON CAVO 220 MM



Fanali LED **12-24V** di ingombro, con cavo da **220mm**.

Ottima qualità e facile montaggio.

Marchio Guidoni.

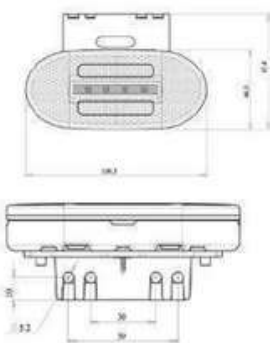

CODICE	POSIZIONE	CARATTERISTICA	COLORE	CF. 
IND8461	Laterale	Cavo con staffa	ARANCIO	1PZ.
IND8464	Posteriore	Cavo con staffa	ROSSO	1PZ.
IND8462	Anteriore	Cavo con staffa	BIANCO	1PZ.

FANALINI DI POSIZIONE CON CAVO 500 MM



Fanali LED **12-24 VOLT**, con cavo da **500mm**.

Click-in di posizione laterali.

Marchio Guidoni.

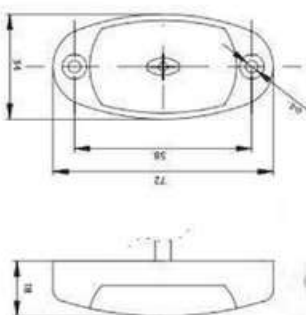

CODICE	POSIZIONE	CARATTERISTICA	COLORE	CF. 
IND8630	Anteriore	Fanalino ingombro LED Base piana con cavo 50cm e click-in	BIANCO	1PZ.
IND8631	Laterale	Fanalino ingombro LED Base piana con cavo 50cm e click-in	ARANCIO	1PZ.
IND8632	Posteriore	Fanalino ingombro LED Base piana con cavo 50cm e click-in	ROSSO	1PZ.



7- Fanalini ingombro LED

FANALINI INGOMBRO LED

Fanalini ingombro LED **12/24V** ovale 3 funzioni con base piana, staffa verticale e piegata, ottima qualità e facile montaggio.

Marchio Guidoni.

IND8636 1 pz. 



Base piana,
misure: 40X150mm

Marchio Guidoni

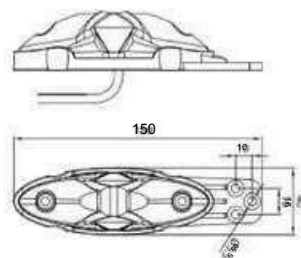

IND8637 1 pz. 



Staffa verticale

misure:

Marchio Guidoni

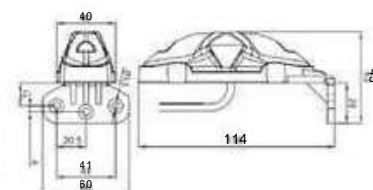

IND8638 1 pz. 



Staffa piegata
misure:

Marchio Guidoni

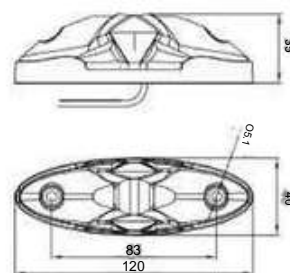

FANALINI CATARIFRANGENTI

dettagli articoli

Fanali LED serie catarifrangente di posizione laterali, forma rettangolare.
12-24V, cavo **500mm**



CODICE	MISURE	POSIZIONE	CARATTERISTICA	LED	COLORE	CF. 
IND8476	130X32x20mm,	Laterale	CON click-in e staffa	2	ARANCIO	1PZ.
IND8476E	130X32x20mm,	Laterale	SENZA click-in e con staffa	3	ARANCIO	1PZ.
IND8475	130X32x20mm,	Laterale	CON click-in e staffa	2	ARANCIO	1PZ.
IND8477	130X32x20mm,	Laterale	CON click-in e staffa	1	ROSSO	1PZ.
IND8477E	130X32x20mm,	Laterale	SENZA click-in e con staffa	3	ROSSO	1PZ.
IND8478	130X32x20mm,	Laterale	CON click-in e staffa	1	BIANCO	1PZ.
IND8478E	130X32x20mm,	Laterale	SENZA click-in e con staffa	3	BIANCO	1PZ.



FANALINI LED CON CAVO CLICK-IN



[dettagli articoli](#)

Fanali LED **12-24VOLT**
con cavo 50cm e click-in.
Ottima qualità e facile montaggio.

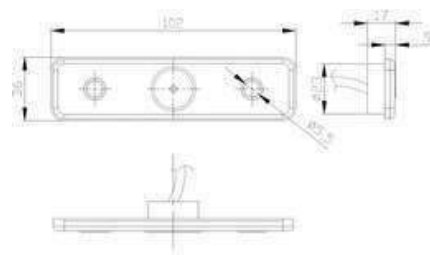

CODICE	POSIZIONE	CARATTERISTICA	COLORE	CF.
IND8634	Anteriore	con cavo 50cm e click-in	BIANCO	1PZ.
IND8633	Laterale	con cavo 50cm, click-in e staffa	ARANCIO	1PZ.
IND8635	Posteriore	con cavo 50cm e click-in	ROSSO	1PZ.

FANALINO INGOMBRO LED ADESIVO

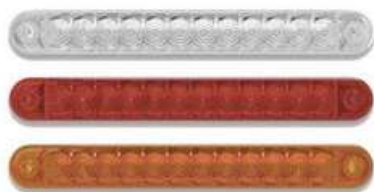

[dettagli articoli](#)

Fanalino LED ingombro **12/24V** con adesivo e cavo **50cm, 22,5X8cm**
Ottima qualità e facile montaggio

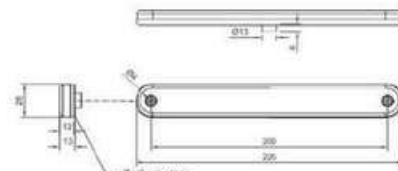

CODICE	POSIZIONE	CARATTERISTICA	COLORE	CF.
IND8639	Anteriore	cavo 50cm, misure: 22,5X8cm	BIANCO	1PZ.
IND8640	Posteriore	cavo 50cm, misure: 22,5X8cm	ROSSO	1PZ.
IND8641	Laterale	cavo 50cm, misure: 22,5X8cm	ARANCIO	1PZ.



[dettagli articoli](#)

Fanalino LED **12/24V**
Ottima qualità e facile montaggio



CODICE	MISURE	FUNZIONE	COLORE	CF.
IND8627	236x20,6x10,4 mm	Freccia dinamica	ARANCIO	1PZ.
IND8628	236x20,6x10,4 mm	freccia dinamica, posizione, stop	ARANCIO	1PZ.
IND8629	236x20,6x10,4 mm	posizione, stop	ROSSO	1PZ.

7- fanali ingombro LED



IND8489 **IND8491** **IND8490** 1 pz.

COLORE **COLORE** **COLORE**
ARANCIO **BIANCO** **ROSSO**

[dettagli articoli](#)

Fanalino laterale side marker 6 LED 24V
misure: 96x 15mm



IND8492A **IND8492B** **IND8492R** 1 pz.

COLORE **COLORE** **COLORE**
ARANCIO **BIANCO** **ROSSO**

[dettagli articoli](#)

Fanalino LED laterale 12/24V side marker con
cavo **20cm**
misure: 60x38mm
interasse fori: 50mm



IND8493A **IND8493B** **IND8493R** 1 pz.

COLORE **COLORE** **COLORE**
ARANCIO **BIANCO** **ROSSO**

[dettagli articoli](#)

Fanalino LED laterale tondo 12/24V side marker
con cavo **13cm**
diametro **20mm**
profondità **21mm**



[dettagli articoli](#)

CODICE	VOLT	MISURE	COLORE	CF.
IND8642	12/24V	31,2x110x22,5mm	ARANCIO	1pz.
IND8643	12/24V	31,2x110x22,5mm	ROSSO	1pz.
IND8644	12/24V	31,2x110x22,5mm	BIANCO	1pz.
IND8645	12/24V	31,2x110x22,5mm	VERDE	1pz.
IND8646	12/24V	31,2x110x22,5mm	BLU	1pz.

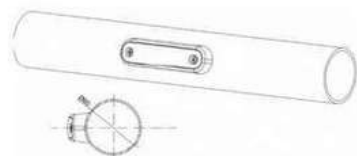

IND8647 4 pz.

Supporto per montaggio su griglie tubolari

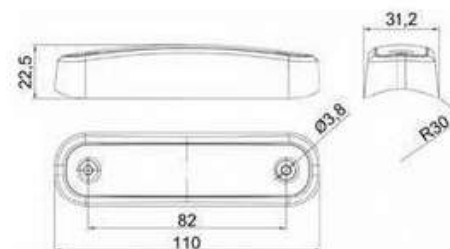

7- fanali ingombro LED

dettagli articoli

Fanalino ingombro LED **12/24V**
misure: 120x46x18 mm

CODICE	DESCRIZIONE	COLORE	CF. 
IND8648	Con cavo 0,5mt	ARANCIO	1PZ.
IND8648E	Con staffa più	ARANCIO	1PZ.
IND8649	Con cavo 0,5mt	ROSSO	1PZ.
IND8649E	Con connessione	ROSSO	1PZ.
IND8650	Cavo 0,5mt	BIANCO	1PZ.
IND8650E	Con connessione	BIANCO	1PZ.

IND8651 4 pz. 

Staffa con fissaggio ad angolo 90°

FANALI DI INGOMBRO "FUORI SAGOMA"

IND8407 4 pz. 

Fanali LED **24V** con cavo **400mm**, N° LED8, di ingombro **rosso**/bianco ingresso dritto.

Marchio Guidoni.

IND8408 4 pz. 

Fanali LED **24V** con cavo **400mm**, N° LED8, di ingombro **rosso**/bianco ingresso a bandiera.

Marchio Guidoni.

IND 8480 4 pz. 

Fanalino LED **12-24V** di ingombro
-misure: 84X103X33mm
-colore bianco/**rosso**/**arancione**

Marchio Guidoni.

IND8481 **IND8482** 1 pz. 

Laterale destro Laterale sinistro

Fanalino LED **12-24V** di ingombro

misure: 135x114x37mm

Marchio Guidoni.



7- fanali ingombro LED



IND8483 **IND8484** 1 pz.

laterale laterale
destro sinistro

Fanalino LED **12-24V** di ingombro

misure: 154x165x37mm

Marchio Guidoni.

FANALINI LATERALE INGOMBRO 3 LED



Fanalini laterali da ingombro 3 LED
con cavo 50cm e CLICK-IN.
Ottima qualità e facile montaggio.

12/24V



CODICE	POSIZIONE	COLORE	CF.
IND8485	laterale sinistra corto	BIANCO, ARANCIO, ROSSO	1pz.
IND8486	laterale destra corto	BIANCO, ARANCIO, ROSSO	1pz.
IND8487	laterale sinistra lungo	BIANCO, ARANCIO, ROSSO	1pz.
IND8488	laterale destra lungo	BIANCO, ARANCIO, ROSSO	1pz.

FANALINI PER LUCI TARGA



IND8411L 2 pz.

Fanalino targa LED 12/24V

misure: 82,5x39mm,

cavo 200m IP67



IND8410 2 pz.

Fanalino targa LED 12/24V **ROSSO** con posizione
con cavo 50cm

misure: 109X55.5X61mm

IP67





IND8428

con cavo e
click-in

IND8428E

con cavo
senza click-in

2 pz. 

dettagli articoli

Fanalini LED smd di posizione **neri** per targa

12-24V n° led 2

Marchio Guidoni.



IND8429

con cavo e
click-in

IND8429E

con cavo
senza click-in

2 pz. 

dettagli articoli

Fanalini LED smd di targa e posizione **rosso**,

12-24V n° led 2

Marchio Guidoni.

FANALI LED POSTERIORI



IND8423L

1pz. 

Fanale posteriore (tipo cobino) LED **12-24V**, forma rettangolare,
misure 14,5x7,5cm
Marchio Guidoni.



IND8527

1pz. 

Fanale posteriore LED **12/24V**
misure: 105X95X38mm
5 funzioni: Posizione, stop, freccia riflettente, luce targa
IP67
temperatura di esercizio: -20°->65°
omologazione

ECE R10 R148 R150
ROHS E9

Marchio Guidoni

IND8528

1pz. 

Fanale anteriore LED **12/24V**
misure: 105X95X38
3 funzioni: posizione, freccia, riflettente **IP67**
temperatura di esercizio: -20°->65°
omologazione:

ECE R10 R148 R150
ROHS E9

Marchio Guidoni



7- fanali posteriori



IND8442

1pz.

Fanale posteriore,
misure:105mmx95mm
LED 10/30V
IP 67
3 funzioni: posizione, stop,
freccia
omologazione: ECE

Marchio Guidoni

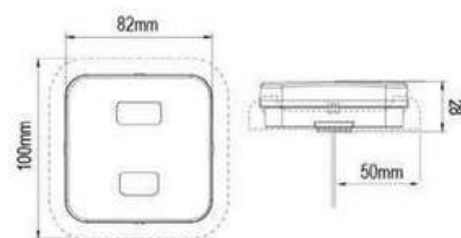

IND8443

1pz.

Fanale anteriore,
misure:105mmx95mm
LED 10/30V
IP 67
2 funzioni: posizione, freccia
omologazione: ECE

Marchio Guidoni

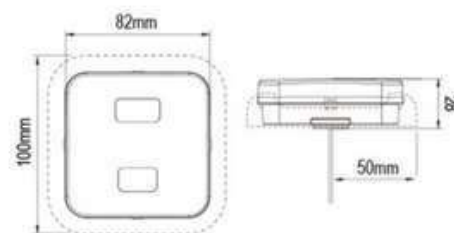

IND8444

1pz.

Fanale posteriore,
misure:105mmx95mm
LED 10/30V
IP 67
2 funzioni: retromarcia, retronebbia
omologazione: ECE

Marchio Guidoni

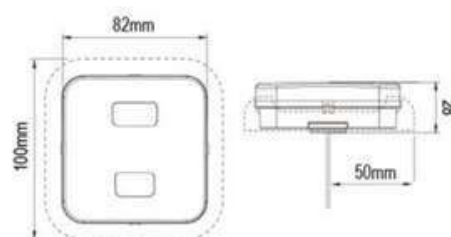

IND8445 IND8446

1 pz.

Retromarcia Retronebbia
BIANCO ROSSO

Dettagli articoli:
fanale posteriore,
misure: 101x81mm LED 12/24V
IP 67 retromarcia bianco

omologazione: ECE

Marchio Guidoni

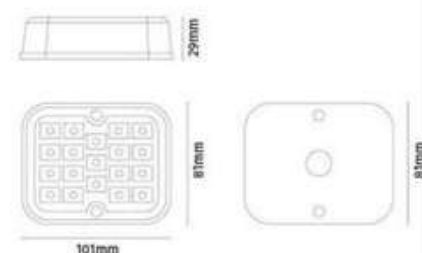

IND8431

1pz.

Kit impianto luci led **12w** wireless 4 funzioni .
il kit comprende: 2 fanali led magnetici, 4 funzioni ricaricabili
con usb, ricevitore integrato per carrelli e rimorchi **12V**.

Marchio Guidoni



7- fanali posteriori



IND8431L

1pz.

Fanali LED posteriori per bisarche, diametro 140mm
2 funzioni: retromarcia, retronebbia **24V.**

Marchio Guidoni



IND8432L

1pz.

Fanali LED posteriori per bisarche, diametro 140mm
3 funzioni: posizione, stop, indicatore di direzione **24V.**

Marchio Guidoni



IND8530

1pz.

Fanali LED posteriori **12/24V**
misure: 220X100X34.4mm
5 funzioni: Posizione, stop, freccia, retromarcia, retronebbia. interasse 152mm, 2viti M6 e cavo da 50cm
IP67
Temperatura di esercizio -20°->60°

omologazione:
ECE R148 R150 R10 CE-RH0S

Marchio Guidoni



IND8531

1pz.

Fanali LED posteriori **12/24V**
misure: 284X100X34.4mm
5 funzioni: Posizione, stop, freccia, retromarcia, retronebbia. interasse 152mm, 2 viti M6 e cavo da 50cm
IP67
Temperatura di esercizio -20°->60°

omologazione:
ECE R148 R150 R10 CE-RH0S

Marchio Guidoni

FANALI LED POSTERIORI RIMORCHIO

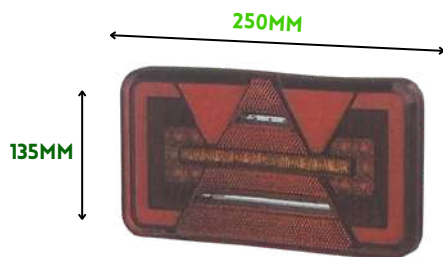

IND8530R

1pz.

Fanali LED posteriori rimorchio destro e sinistro **12/24V**
misure: 250X135X36mm
5 funzioni: Posizione, stop, freccia, retromarcia, retronebbia interasse 152mm, 2viti M6 e cavo da 50cm
IP67
Temperatura di esercizio -20°->60°

omologazione:
ECE R148 R150 R10 CE-RH0S



IND8531R

1pz. 

Fanali LED posteriori rimorchio destro e sinistro **12/24V**

misure: 430X135X36mm

5 funzioni: Posizione, stop, freccia, retromarcia, retronebbia

interasse 152mm

2viti M6 e cavo da 50cm

IP67

Temperatura di esercizio -20°->60°

omologazione:

ECE R148 R150 R10 CE-RH0S

Marchio Guidoni

FANALI POSTERIORI

dettagli articoli

Lenti e fanali con attacco per connettore 4 pin, di posizione posteriore, con forma rettangolare per camion.

applicazioni: IVECO E UNIVERSALI

CODICE	POSIZIONE	MISURE	TIPO	CF. 
IND8414	posteriore sinistro	303X130mm	LENTE	1PZ.
IND8415	posteriore destro	303X130mm	LENTE	1PZ.
IND8416	posteriore sinistro	303X130mm	FANALE	1PZ.
IND8417	posteriore destro	303X130mm	FANALE	1PZ.

IND8517

2 pz. 

Raccordo per fanali IND8416, IND8417

Marchio Guidoni.

IND8523

IND8524

1 pz. 

Destro

Sinistro

dettagli articoli

Fanali posteriori con attacco per connettore 5 pin, applicazioni: IVECO daily 2000 (10/99 >06).

misure:303x130mm

IND8438

IND8439

1 pz. 

Destro

Sinistro

dettagli articoli

Fanali posteriori con doppio connettore 3+10 pin applicazioni: IVECO eurocargo

misure:303x130mm



7- fanali posteriori



dettagli articoli

Fanali posteriori con attacco per connettore 7 pin, applicazioni: IVECO daily ('06>) eurocargo ('06>).

misure:303x130mm

CODICE	POSIZIONE	MISURE	TIPO	CF.
IND8418	posteriore destro	303X130mm	FANALE	1PZ.
IND8419	posteriore sinistro	303X130mm	FANALE	1PZ.
IND8420	posteriore sinistro	303X130mm	LENTE	1PZ.
IND8421	posteriore destro	303X130mm	LENTE	1PZ.

IND8532 **IND8532LT** **IND8533** 1 pz.

Fanale Fanale Lente
DX-SX SX DX-SX
con luce targa



dettagli articoli

Fanali posteriori con attacco per connettore 7 pin, con ghiera e pipetta in gomma.

misure:303x130mm

dettagli articoli

Fanali posteriori con attacco per connettore 10 pin 7 funzioni.

applicazioni: iveco.

Marchio Guidoni.



CODICE	POSIZIONE	MISURE	TIPO	CF.
IND8455D	posteriore destro	466X130mm	FANALE	1PZ.
IND8455S	posteriore sinistro	466X130mm	FANALE	1PZ.
IND8456	posteriore sinistro, luce targa	466X130mm	FANALE	1PZ.
IND8466	posteriore	466X130mm	LENTE	1PZ.

IND8704D **IND8704S** **IND8704L** 1 pz.

Fanale Fanale Lente
DX SX DX-SX
full LED full LED



dettagli articoli

Fanali posteriori full LED con attacco per connettore 10 pin 7 funzioni.

applicazioni: iveco.

Marchio Guidoni.



7- fanali posteriori



dettagli articoli

Fanali posteriori con attacco per connettore 7 pin,

Applicazione: mercedes, actros
misure: 522x141mm

Marchio Guidoni.



CODICE	TIPO	CF. 
IND8504	Fanale SX con luce targa	1PZ.
IND8505	Fanale DX	1PZ.
IND8510	Lente posteriore SX	1PZ.
IND8511	Lente posteriore SX	1PZ.

FANALI POSTERIORI RIMORCHIO

EUROPOINT 1

dettagli articoli

Fanali posteriori rimorchio con triangolo tipo ASPOCK
europoint 1
con attacco per connettore 7 pin.

Marchio Guidoni.



CODICE	POSIZIONE	MISURE	TIPO	CF. 
IND8506	posteriore destro,	421X147mm	FANALE	1PZ.
IND8507	posteriore sinistro,	421X147mm	FANALE	1PZ.
IND8500	posteriore DX/SX	421X147mm	LENTE	1PZ.

EUROPOINT 2

Fanali posteriori rimorchio con triangolo tipo ASPOCK
europoint 2
con attacco per connettore 7 pin.

A



B



C



CODICE	CODICE ORIGINALE	TIPO	FIGURA
IND8784S	256000501	FANALE SX	A
IND8784D	256400501	FANALE DX	A
IND8785S	256021701	FANALE SX con luce ingombro	B
IND8785D	256041701	FANALE DX con luce ingombro	B
IND8784L	188560002	LENTE DX/SX	C



7- fanali posteriori

EUROPOINT 3

Fanali posteriori rimorchio con triangolo tipo ASPOCK
europoint 3
con attacco per connettore 7 pin.



CODICE	CODICE ORIGINALE	TIPO	FIGURA
IND8786S	257000501	FANALE SX	A
IND8786D	257400501	FANALE DX	A
IND8787S	257020501	FANALE SX con luce ingombro	B
IND8787D	257420501	FANALE DX con luce ingombro	B
IND8786LS	188570101	LENTE SX	C
IND8786LD	188570001	LENTE DX	C

RACCORDI POSTERIORI UNIVERSALI KRONE



CODICE	TIPO	DESCRIZIONE	FIGURA
IND8788D	FANALE DX	universale KRONE	A
IND8788S	FANALE SX	universale KRONE	A
IND8789D	FANALE DX	universale KRONE con luce ingombro	B
IND8789S	FANALE SX	universale KRONE con luce ingombro	B
IND8790D	FANALE DX	universale KRONE con posizione stop a LED	C
IND8790S	FANALE SX	universale KRONE con posizione stop a LED	C
IND8788LD	LENTE DX	universale KRONE	D
IND8788LS	LENTE SX	universale KRONE	D



UNIVERSALI

dettagli articoli



Fanale full LED universale. canbus integrato. tensione 24V, connettore CON2243 7 vie, interasse perni 152mm

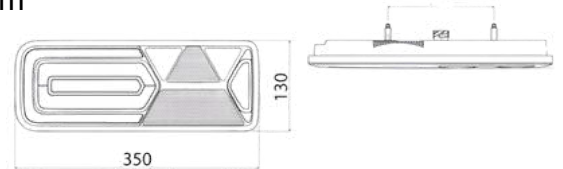

CODICE	POSIZIONE	TIPO	CF.
IND8780	Fanale SX	MOTRICE	1PZ.
IND8781	Fanale DX	MOTRICE	1PZ.
IND8782	Fanale SX	RIMORCHIO con triangolo	1PZ.
IND8783	Fanale DX	RIMORCHIO con triangolo	1PZ.



CON2243 2pz.

Connettore per fanali 7 poli, tipo di contatto femmina

IVECO

IND8700 **IND8701** 1pz.

Fanale full LED SX

Fanale full LED DX

dettagli articoli

Fanale full LED posteriore. iveco strolls/trakker. 24V, connettore hdscs 8 vie CON2277 interasse 152mm

IND8702 **IND8703** 1pz.

Lente SX per fanale full LED iveco stralis /trukker

Lente DX per fanale full LED iveco stralis /trukker



CON2277 1pz.

Connettore per fanale 8 poli, tipo di contatto femmina

VOLVO

IND8740

IND8741

1pz. 



Fanale full LED
SX

Fanale full LED
DX

dettagli articoli

Fanale full LED destro **con luce targa**
volvo fh 12.2012 24V, connettore
CON2243,
1,5AMP, 7 vie laterale
interasse 160 mm.

IND8743

IND8744

1pz. 



Fanale full LED
SX

Fanale full LED
DX

dettagli articoli

Fanale full LED **con luce targa**
volvo fm 09.2013 24V,
connettore CON2243,
interasse 160 mm.

IND8742

IND8745

1pz. 



Lente DX/SX
per fanale full LED
volvo fh 12.2012
24V

Lente DX/SX
per fanale full LED
volvo fm 09.2013
24V

MERCEDES

IND8760

IND8761

1pz. 



Fanale full LED
sinistro

Fanale full LED
destro

dettagli articoli

Fanale full LED mercedes sprinter/pick-up 2006
12v, connettore CON2243,
1,5 AMP, posteriore a 7 vie

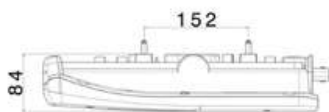
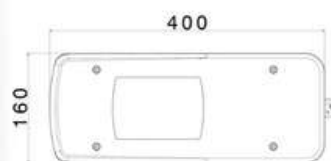

MAN



IND8770 1pz.

Lente sinistra man tge/tga/tgl/tgm/tgx 2005

IND8771 1pz.

Lente destra man tge/tga/tgl/tgm/tgx 2005

SCANIA



IND8720 **IND8721** 1pz.

Fanale posteriore
SX

Fanale posteriore
DX

dettagli articoli

Fanale posteriore **con luce targa** scania serie iv p-r
12-24V, connettore CON2243,
1,5AMP, interasse 152mm
connettore posteriore

IND8722 **IND8723** 1pz.

Fanale posteriore
SX

Fanale posteriore
DX

dettagli articoli

Fanale posteriore **con luce targa** scania serie iv p-r
12-24V, connettore CON2243,
1,5AMP, interasse 152mm
connettore laterale



IND8724 **IND8725** 1pz.

Lente posteriore
SX

Lente posteriore
DX

Lenti per fanali posteriore scania serie iv p-r dal 2007->



CONNETTORI PORTA LAMPADA SERIE T 10



IND8395 10 pz. 

Connettore porta lampada serie t10

Marchio Guidoni



IND8396 10 pz. 

Connettore porta lampada serie t10 cablato

Marchio Guidoni



IND8398 10 pz. 

Connettore porta lampada serie t10 mini timer

Marchio Guidoni



IND8401 10 pz. 

Connettore porta lampada serie t10 superseal, di
posizioni laterali

Marchio Guidoni

CONNETTORI PORTA LAMPADA SERIE H6



IND8399 10 pz. 

Connettore porta lampada cablato attacco ba9s

Marchio Guidoni

CONNETTORI PORTALAMPADA BA 15S



IND8400 10 pz. 

Connettore porta lampada attacco ba15s

Marchio Guidoni

RACCORDI PER FANALI CON ATTACCO 7 PIN



IND8514

1pz.

KIT connettore 7 VIE porta femmina **giallo** ASS2 per fanali ASPOCK a vite e baionetta



IND8513

1pz.

KIT connettore 7 VIE porta femmina **verde** ASS2 per fanali ASPOCK a vite e baionetta



IND8512

1pz.

KIT connettore 7 VIE porta femmina **verde/giallo** ASS2 per fanali ASPOCK a vite e baionetta



IND8521

1pz.

KIT connettore 7 VIE porta femmina per fanali posteriori HELLA EASY CONN



CON2243G

1pz.

KIT connettore 7 VIE grigio per autocarri



CON2250

1pz.

KIT connettore 4 VIE porta femmina ghiera grigia per sensore e elettrovalvola truck

