

FUSIBILI

3

E PORTAFUSIBILI



CAPITOLO 3

- Fusibili e Portafusibili
- Moduli, Frames e Accessori



FUSIBILI

E PORTAFUSIBILI





3- fusibili e portafusibili

FUSIBILI LAMELLARI UNI E UNI LED

Fusibili serie uni lamellari e uni led, I modelli led ti segnalano quando il fusibile ha un malfunzionamento illuminandosi,

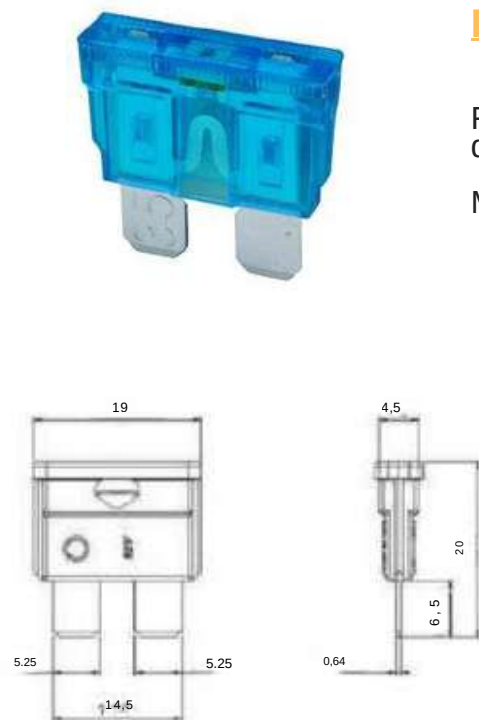
Marchio Guidoni.



CODICE KIT	AMPERE	COLORE	TIPO	CF. 
FUS4001	1A	NERO		100PZ.
FUS4002	2A	GRIGIO		100PZ.
FUS4003	3A	VIOLA		100PZ.
FUS4004	4A	ROSA		100PZ.
FUS4005	5A	BEIGE		100PZ.
FUS4006	7,5A	MARRONE		100PZ.
FUS4007	10A	ROSSO		100PZ.
FUS4008	15A	BLU		100PZ.
FUS4009	20A	GIALLO		100PZ.
FUS4010	25A	TRASPARENTE		100PZ.
FUS4011	30A	VERDE		100PZ.
FUS4012	40A	ARANCIONE		100PZ.
FUS4050	2A	GRIGIO	LED	50PZ.
FUS4051	3A	VIOLA	LED	50PZ.
FUS4052	4A	ROSA	LED	50PZ.
FUS4053	5A	BEIGE	LED	50PZ.
FUS4054	7,5A	MARRONE	LED	50PZ.
FUS4055	10A	ROSSO	LED	50PZ.
FUS4056	15A	AZZURRO	LED	50PZ.
FUS4057	20A	GIALLO	LED	50PZ.
FUS4058	25A	TRASPARENTE	LED	50PZ.
FUS4059	30A	VERDE	LED	50PZ.
FUS4060	35A	VERDE SCURO	LED	50PZ.
FUS4061	40A	ROSSO SCURO	LED	50PZ.

KIT FUSIBILI UNI



FUS4014

Kit fusibili serie uni tipo lamellari - marchio guidoni In un box in plastica, troverai un totale di 110 fusibili lamellari:

- 10 da 3 ampere,
- 10 da 4 ampere,
- 10 da 5 ampere,
- 10 da 7,5 ampere,
- 10 da 10 ampere,
- 10 da 15 ampere,
- 10 da 20 ampere,
- 10 da 25 ampere,
- 10 da 30 ampere,
- 10 da 40 ampere

articoli correlati

FUS 4099
FUS4468
FUS 4119



FUSIBILI LAMELLARI 80V



- **materiale:** Rame stagnato
- Adatto per l'uso di applicazioni a bassa tensione fino a 80v DC
- Capacità di rottura 1000A A 80V DC
- Controllare il fusibile nel blocco fusibile utilizzando i punti di prova in cima al fusibile
- Rigidità nella lama grazie alla costruzione

Marchio Guidoni.

CODICE	AMPERE	COLORE	CF. 
FUS4003-80	3A	VIOLA	10PZ.
FUS4004-80	4A	ROSA	10PZ.
FUS4005-80	5A	BEIGE	10PZ.
FUS4006-80	7,5A	MARRONE	10PZ.
FUS4007-80	10A	ROSSO	10PZ.
FUS4008-80	15A	BLU	10PZ.
FUS4009-80	20A	GIALLO	10PZ.
FUS4010-80	25A	BIANCO	10PZ.
FUS4011-80	30A	VERDE	10PZ.



FUSIBILI RIPRISTINABILI



Fusibili ripristinabili uni, sono in grado di garantirti il massimo controllo grazie all'interruttore termico automatico.

Marchio Guidoni.

CODICE	AMPERE	COLORE	CF. 
FUS4036	5A	BEIGE	1 PZ.
FUS4030	7,5A	MARRONE	1 PZ.
FUS4031	10A	ROSSO	1 PZ.
FUS4032	15A	BLU	1 PZ.
FUS4033	20A	TRASPARENTE	1 PZ.
FUS4034	25A	GIALLO	1 PZ.

FUS4037

Kit fusibili uni-ripristinabili uni fuse circuit breaker, Marchio Guidoni.

Kit composto da:

- FUS4030
- FUS4031
- FUS4032
- FUS4033
- FUS4034
- FUS4035



3- fusibili e portafusibili

FUSIBILI UNI CON DERIVAZIONE



Fusibili uni muniti di un cavo di derivazione che ti permetterà di aggiungere una linea di corrente ed aumentare i collegamenti del tuo impianto.

Marchio Guidoni.

CODICE	AMPERE	COLORE	CF 
FUS4017	10	ROSSO	1 PZ.
FUS4018	15	BLU	1 PZ.
FUS4019	20	GIALLO	1 PZ.
FUS4020	25	TRASPARENTE	1 PZ.
FUS4021	30	VERDE	1 PZ.

PORTA FUSIBILI UNI CON DERIVAZIONE

Portafusibili per fusibili uni 2 vie.

Marchio Guidoni.



CODICE	CF. 
FUS4022	2 PZ.
FUS4022/10	10 PZ.

COPERCHI PORTAFUSIBILI UNI

FUS4501 25 pz. 

Coperchio serie uni tipo lamellari per portafusibili 1 via,

Marchio Guidoni.

articoli correlati

FUS4524

FIS3004

PORTAFUSIBILI UNI COMPONENTI

FUS4500 25 pz. 

Portafusibili componibili serie uni tipo lamellari 1 via,

Marchio Guidoni.

articoli correlati

FUS 4500

PORTAFUSIBILI CON USCITE LATERALI

FUS4524 25 pz. 

Portafusibili componibili serie uni uscite laterali tipo lamellari 1 via,

Marchio Guidoni.

articoli correlati

FUS4510

FUS4500

FUS4506



PORTAFUSIBILI UNI PER FIAT



FUS4506

25 pz. 

Portafusibili componibili serie uni tipo lamellari 1 via,

Marchio mta per fiat.

articoli correlati

TER1333

TER133

FIS3020

FUS4507

25 pz. 



portafusibili componibili serie uni tipo lamellari 1 via,

Marchio mta per fiat nuovo tipo.

articoli correlati

TER 1333

TER 1334

PORTAFUSIBILI UNI DA INCASSO



FUS4543

2 pz. 

Portafusibili elettrici con led 1 via da incasso,

Marchio Guidoni.

PORTAFUSIBILI UNI STAGNI



FUS4504

10 pz. 

Kit portafusibile 2 vie tenuta stagna per cavo ->10MMQ
portata massima 60AMP (40+40)



FUS4505

sezione cavo
4mm²

FUS4505-25

sezione cavo
2,5mm²

FUS4505-15

sezione cavo
1,5mm²

10pz. 

dettagli articoli

Portafusibili a tenuta stagna, volanti serie uni per fusibili tipo lamellari

3- fusibili e portafusibili



FUS4505L

5 pz.

Portafusibili led stagni volanti 1 via per fusibili uni lamellari, sezione cavo 4mm²
Marchio Guidoni.

articoli correlati

FUS 4530
FUS4505
FUS4524



FUS 4544

2 pz

Portafusibile stagno per fusibili ato

Marchio Guidoni.



FUS 4537

5 pz.

Portafusibili a tenuta stagna per fusibili ATO

Marchio Guidoni.

PORTAFUSIBILI DA INCASSO



FUS4517

2 pz

Portafusibili serie uni da incasso tipo lamellari 8 vie,
Marchio mta.

articoli correlati

FUS 4519
FUS 4523
FUS 4518

PORTAFUSIBILI UNI CON USCITE LATERALI



FUS4554

2pz

Portafusibile serie uni 2 vie uscite laterali per fusibili ATO

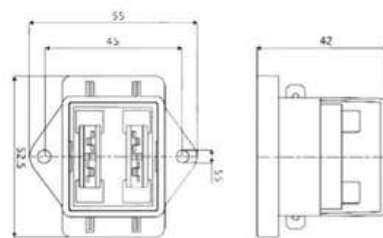

FUS4559

1pz

Portafusibile serie uni 12 vie uscite laterali per fusibili ATO

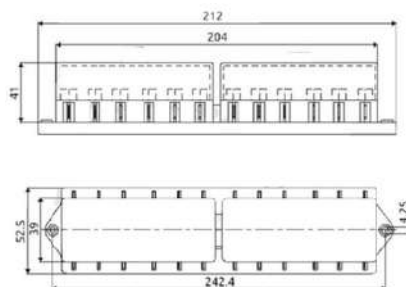

PORTAFUSIBILI CON USCITE ASSIALI



FUS4519 2 pz

Portafusibili serie uni uscite assiali tipo lamellari 4 vie, Marchio mta.

articoli correlati

FUS 4523
FUS4518
FUS4517



FUS4521 2 pz

Portafusibili serie uni uscite assiali tipo lamellari 6 vie, Marchio mta.

articoli correlati

FUS 4523
FUS4522
FUS4517

PORTAFUSIBILI UNI LED



FUS4540 1 pz

Portafusibili serie uni led tipo lamellari 4 vie, in caso di fusibile bruciato si accende il led corrispondente.

Marchio Guidoni.

articoli correlati

FUS4519
FUS4518
FUS 4545



FUS4541 1 pz

Portafusibili , serie uni led tipo lamellari 6 vie, in caso di fusibile bruciato si accende il led corrispondente, Marchio Guidoni.

articoli correlati

FUS4546
FUS4521
FUS 4522



FUS4542 1 pz

Portafusibili, serie uni led tipo lamellari 10 vie, in caso di fusibile bruciato si accende il led corrispondente, Marchio Guidoni.

articoli correlati

FUS4527
FUS4547
FUS4512



KIT PORTAFUSIBILE CON POSITIVO IN COMUNE



FUS4553

1 pz 

Kit portafusibili a 8 vie per fusibili ATO massimo
voltage 32VDC 100 ampere-
positivo in comune



FUS4553-4

1 pz 

Kit portafusibili a 4 vie per fusibili ATO massimo voltage
32VDC 100 ampere-
positivo in comune

3- fusibili e portafusibili

FUSIBILI MINI E MINI LED

Fusibili mini lamellari e mini led lamellari. I modelli led segnalano quando il fusibile ha un malfunzionamento illuminandosi.

Marchio Guidoni.

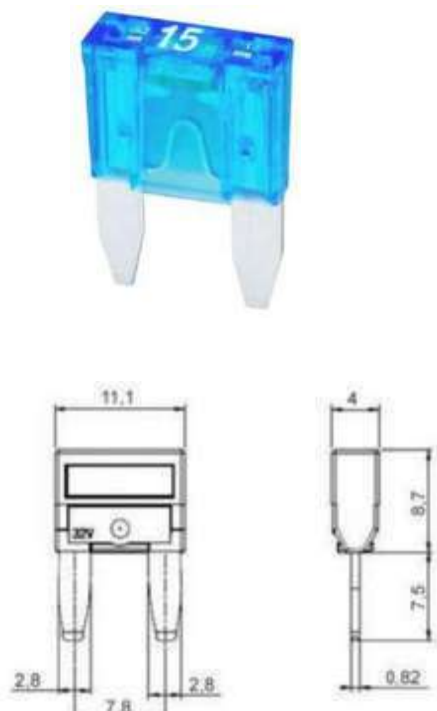

CODICE	AMPERE	COLORE	TIPO	CF. 
FUS4109	2A	GRIGIO		50 PZ.
FUS4110	3A	VIOLA		50 PZ.
FUS4111	4A	ROSA		50 PZ.
FUS4112	5A	BEIGE		50 PZ.
FUS4113	7,5A	MARRONE		50 PZ.
FUS4114	10A	ROSSO		50 PZ.
FUS4115	15A	BLU		50 PZ.
FUS4116	20A	GIALLO		50 PZ.
FUS4117	25A	TRASPARENTE		50 PZ.
FUS4118	30A	VERDE		50 PZ.
FUS4062	2A	GRIGIO	LED	20 PZ.
FUS4063	3A	VIOLA	LED	20 PZ.
FUS4064	4A	ROSA	LED	20 PZ.
FUS4065	5A	BEIGE	LED	20 PZ.
FUS4066	7,5A	MARRONE	LED	20 PZ.
FUS4067	10A	ROSSO	LED	20 PZ.
FUS4068	15A	BLU	LED	20 PZ.
FUS4069	20A	GIALLO	LED	20 PZ.
FUS4070	25A	TRASPARENTE	LED	20 PZ.
FUS4071	30A	VERDE	LED	20 PZ.

KIT FUSIBILI MINI

FUS4119

Kit fusibili, serie mini tipo lamellari troverai un totale di 155 pezzi dei seguenti mini fusibili:

5 fusibili mini da 3 ampere,
5 da 3 ampere,
10 da 5 ampere,
10 da 5 ampere,
25 da 10 ampere,
25 da 15 ampere,
25 da 20 ampere,
25 da 25 ampere,
25 da 30 ampere



Marchio Guidoni

articoli correlati

FUS4140
FUS4467
FUS4468



3- fusibili e portafusibili

FUSIBILI MINI RIPRISTINABILI



Fusibili ripristinabili mini-lamellari dotati di un' interruttore termico unipolare e in grado di staccare in caso di sovracorrenti, per poi ritornare in posizione di riposo, e permettere nuovamente il corretto funzionamento del circuito.

Marchio Guidoni.

CODICE	AMPERE	COLORE	CF 
FUS4040	5A	BEIGE	1 PZ.
FUS4041	7,5A	MARRONE	1 PZ.
FUS4042	10A	ROSSO	1 PZ.
FUS4043	15A	BLU	1 PZ.
FUS4044	20A	GIALLO	1 PZ.
FUS4045	25A	TRASPARENTE	1 PZ.
FUS4046	30A	VERDE	1 PZ.

FUSIBILI MINI CON DERIVAZIONE



Fusibili mini lamellari con cavo di derivazione protettivo e isolante
Marchio Guidoni.

CODICE	AMPERE	COLORE	CF 
FUS4124	10	ROSSO	5 PZ.
FUS4125	15	BLU	5 PZ.
FUS4126	20	GIALLO	5 PZ.
FUS4127	25	TRASPARENTE	5 PZ.
FUS4128	30	VERDE	5 PZ.

FUSIBILI MINICON TERMINALE DI PRESA DI CORRENTE



MARCHIO
GUIDONI.

CODICE	AMPERE	COLORE	CF 
FUS4159	3	VIOLA	5 PZ.
FUS4160	5	OCRA	5 PZ.
FUS4161	7,5	ARANCIONE	5 PZ.
FUS4162	10	ROSSO	5 PZ.
FUS4163	40	CELESTE	5 PZ.
FUS4164	20	GIALLO	5 PZ.
FUS4165	25	GRIGIO	5 PZ.
FUS4166	30	VERDE	5 PZ.





FUS4167

Assortimento fusibili mini con terminale di presa di corrente

Applicazioni:
fusibili mini, vari amperaggi con terminale di presa di corrente FUS4167 Kit assortimento

PORTAFUSIBILI MINI CON DERIVAZIONE



FUS4029 2 pz 

FUS4029/10 10 pz 

I portafusibili mini lamellari Guidoni con derivazione, che consente l'aggiunta di due linee di corrente al tuo impianto. Questo tipo di portafusibili ti darà la possibilità di inserire un secondo mini fusibile per una protezione ottimale dagli sbalzi di corrente.

Marchio Guidoni.

PORTAFUSIBILI MINI

FUS4508 10 pz 



Portafusibili componibili serie mini Marchio Guidoni.

articoli correlati

FUS 4527
TER 1321
FUS4512



FUS 4537M 10 pz 

Portafusibile a tenuta stagna per fusibili mini

KIT PORTAFUSIBILI MINI

FUS4512 2 pz 

KIT portafusibili componibili serie mini. Il kit consiste in:

- 1 portaminifusibile con coperchio relativo,
- 2 gommini passacavo sz. 150mm gialli,
- 2 faston.

Marchio Guidoni.

articoli correlati

FUS 4508
FUS4527



PORTAFUSIBILI MINI STAGNI VOLANTI

FUS4527 **FUS4527-15** 2 pz 

sezione cavo
2.5mm²

sezione cavo
1.5mm²

dettagli articoli:

Portafusibili serie mini volanti tipo lamellari 1 via,

Marchio Guidoni.

articoli correlati

FUS 4527L
FUS4508
FUS4512

FUS4527L 2 pz 

Portafusibili led a tenuta stagna volanti per fusibili

serie mini tipo lamellari, sezione cavo 2.5 mm²

Marchio Guidoni.

articoli correlati

FUS 4527
FUS4508
FUS4512

PORTAFUSIBILI MINI LED

FUS4545 1 pz. 

Portafusibili serie mini led tipo lamellari 4 vie, sezione cavo 4mm²
in caso di fusibile bruciato si accende il led corrispondente
Marchio Guidoni.

articoli correlati

FUS4540
FUS4527
FUS4512

FUS4546 1 pz. 

Portafusibili serie mini led tipo lamellari 6 vie,

in caso di fusibile bruciato si accende il led corrispondente

Marchio Guidoni.

articoli correlati

FUS 4541
FUS4527
FUS4512



3- fusibili e portafusibili



FUS4547

1 pz. 

Portafusibili serie mini led tipo lamellari 10 vie,
in caso di fusibile bruciato si accende il led corrispondente

Marchio Guidoni.

articoli correlati
FUS 4542



FUS4529

1 pz. 

Kit portafusibili serie mini 7 vie.
all'interno di questo kit troverai:

- portafusibile
 - 14 gommini passacavo,
 - 14 faston ed un coperchio semitrasparente.
- Marchio mta

articoli correlati
FUS 4508
FUS4527
FUS4512

FUSIBILI MAXI



Fusibili serie maxi lamellari e led lamellari .
I modelli led segnalano quando un fusibile ha un
malfunzionamento illuminandosi.

Marchio Guidoni,

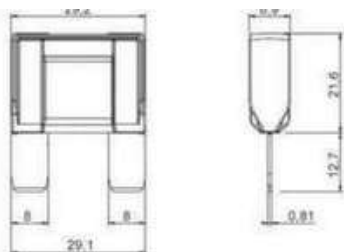

CODICE	AMPERE	COLORE	TIPO	CF. 
FUS4100	20A	GIALLO		10PZ.
FUS4101	30A	VERDE		10PZ.
FUS4102	40A	ARANCIONE		10PZ.
FUS4103	50A	ROSSO		10PZ.
FUS4104	60A	BLU		10PZ.
FUS4105	70A	BEIGE		10PZ.
FUS4106	80A	TRASPARENTE		10PZ.
FUS4107	100A	VIOLA		10PZ.
FUS4072	20A	GIALLO	LED	4PZ.
FUS4073	30A	VERDE	LED	4PZ.
FUS4074	40A	ARANCIONE	LED	4PZ.
FUS4075	50A	ROSSO	LED	4PZ.
FUS4076	60A	BLU	LED	4PZ.
FUS4077	70A	BEIGE	LED	4PZ.
FUS4078	80A	TRASPARENTE	LED	4PZ.
FUS4079	100A	VIOLA	LED	4PZ.



KIT FUSIBILI MAXI

FUS4099

Kit fusibili serie maxi tipo lamellari,
nel kit troverai 32 fusibili maxi così divisi:
2 fusibili da 20 ampere,
2 da 30 ampere,
2 da 40 ampere,
2 da 50 ampere,
2 da 60 ampere,
2 da 70 ampere,
2 da 80 ampere,
2 da 100 ampere.

Marchio Guidoni,

articoli correlati

FUS4014
FUS4467
FUS4468



MAXI FUSIBILI LAMELLARI 80V

Materiale:

Rame, stagnato adatto per l'uso in applicazioni a bassa tensione fino a 80V DC capacità di rottura 1000A, A 80 VDC rigidità della lama grazie alla costruzione

Marchio Guidoni,

2 PZ 



CODICE	DESCRIZIONE	COLORE
FUS 4100-80	MAXIFUSIBILE 20 AMP, 80 V	GIALLO
FUS 4101-80	MAXIFUSIBILE 30 AMP, 80 V	VERDE
FUS 4102-80	MAXIFUSIBILE 40 AMP, 80 V	BEIGE
FUS 4103-80	MAXIFUSIBILE 50 AMP, 80 V	ROSSO
FUS 4104-80	MAXIFUSIBILE 60 AMP, 80 V	AZZURRO
FUS 4105-80	MAXIFUSIBILE 70 AMP, 80 V	MARRONE
FUS 4106-80	MAXIFUSIBILE 80 AMP, 80 V	BIANCO
FUS 4107-80	MAXIFUSIBILE 100 AMP, 80 V	VIOLA



PORTAFUSIBILI MAXI



FUS4502

5 pz.

Portafusibili componibili serie maxi 1 via,
Marchio mta.

articoli correlati

FUS 4533
TER 1327
TER 1329



FUS4533

5 pz.

Portafusibili serie maxi 1 via,

Marchio mta.

articoli correlati

FUS4526L
FUS4502



FUS4551

1 pz.

Kit portamaxi fusibile stagno per cavo **4->6mm²**
completo di terminali gommini e coperchio



FUS4552

1 pz.

Kit portamaxi fusibile stagno per cavo **6->10mm²**
completo di terminali gommini e coperchio

PORTAFUSIBILI MAXI STAGNI



FUS4526

2 pz.

Portafusibili serie maxi stagni volanti 1 via,
sezione cavo **10mm²**

Marchio Guidoni

articoli correlati

FUS4526L
FUS4502
FUS 4533



FUS4526L

2 pz.

Portafusibili LED a tenuta stagna, volanti, a 1 via
per fusibili serie maxi tipo lamellari.
Marchio Guidoni

articoli correlati

FUS4626
FUS4502





TESTER PROVA - FUSIBILI

FUS4000 1 pz. 

Tester prova fusibili serie mini-uni-maxi tipo lamellari,
Marchio Guidoni,

articoli correlati

FUS4115
FUS4104
FUS 4007



FUSIBILI MAXICOMPACT

CODICE	AMPERE	CF. 
FUS4084	25A	10PZ.
FUS4085	30A	10PZ.
FUS4086	35A	10PZ.
FUS4087	40A	10PZ.
FUS4088	50A	10PZ.
FUS4089	60A	10PZ.

KIT FUSIBILI MAXICOMPACT

FUS4090 1 pz. 

Kit fusibili serie maxicompact.
Composto da 24 pezzi assortiti.



FUSIBILI M8COMPACT

Fusibili serie m8compact, solidi e pratici, con un design
all'avanguardia,

Marchio mta.



CODICE	AMPERE	CF. 
FUS4091	30A	10PZ.
FUS4092	35A	10PZ.
FUS4093	40A	10PZ.
FUS4094	50A	10PZ.
FUS4095	60A	10PZ.
FUS4096	70A	10PZ.
FUS4097	80A	10PZ.

KIT FUSIBILI M8COMPACT



FUS4098 1 pz.

Kit fusibili serie m8compact composto da 28 pezzi assortiti.

FUSIBILI MICRO 3

Fusibili micro 3 lamellari, si distinguono per i 3 terminali allineati, collegati con un terminale centrale in comune a tutti.



CODICE	AMPERE	COLORE	CF.
FUS4469	5A	BEIGE	10PZ.
FUS4470	7,5A	MARRONE	10PZ.
FUS4471	10A	ROSSO	10PZ.
FUS4472	15A	BLU	10PZ.

KIT FUSIBILI MICRO 3

FUS4468 1 pz.

Kit fusibili serie micro 3. Un assortimento di qualità per un totale di 20 componenti. troverai:

5 da 3,5AMP,
5 da 7,5AMP,
5 da 10AMP,
5 da 7,5AMP,
5 da 10AMP,
5 da 15AMP.

articoli correlati

FUS 4467
FUS 4140
FUS 4119

portafusibili micro 3 con derivazione



FUS4475 2 pz.

Portafusibili con derivazione per fusibili micro 3

FUSIBILI MICRO 2



CODICE	AMPERE	COLORE	CF. 
FUS4460	5A	BEIGE	20 PZ.
FUS4461	7,5A	MARRONE	20 PZ.
FUS4462	10A	ROSSO	20 PZ.
FUS4463	15A	BLU	20 PZ.
FUS4464	20A	GIALLO	20 PZ.
FUS4465	25A	TRASPARENTE	20 PZ.
FUS4466	30A	VERDE	20 PZ.

KIT FUSIBILI MICRO 2

FUS4467

1 pz. 

Kit fusibili serie micro per FCA
dentro il box troverai:

70 fusibili micro2, così assortiti:

10 fusibili micro da 5AMP,

10 da 7,5 AMP,

10 da 15AMP,

10 da 20AMP,

10 da 30AMP.

articoli correlati

FUS4468

FUS4140

FUS4119

PORTAFUSIBILI MICRO 2

FUS4538

5 pz. 

Portafusibili micro 2 stagni.

PORTAFUSIBILI ADD-A-CIRCUIT MICRO 2

FUS4459

2 pz. 

Portafusibili ADD-A-CIRCUIT con derivazione per fusibili micro 2,

una novità per raddoppiare la sicurezza del tuo circuito

articoli correlati

FUS4467



3- fusibili e portafusibili

FUSIBILI LOW PROFILE



Fusibili LOW profile e LOW profile LED. I modelli LED segnalano quando un fusibile ha un malfunzionamento illuminandosi.

Marchio Guidoni.

CODICE	AMPERE	COLORE	TIPO	CF. 
FUS4130	2	GRIGIO		10PZ.
FUS4131	3	VIOLA		10PZ.
FUS4132	4	ROSA		10PZ.
FUS4133	5	BEIGE		10PZ.
FUS4134	7,5	MARRONE		10PZ.
FUS4135	10	ROSSO		10PZ.
FUS4136	15	BLU		10PZ.
FUS4137	20	GIALLO		10PZ.
FUS4138	25	TRASPARENTE		10PZ.
FUS4139	30	VERDE		10PZ.
FUS4142	2	VERDE	LED	10PZ.
FUS4143	3	VIOLA	LED	10PZ.
FUS4144	4	ROSA	LED	10PZ.
FUS4145	5	BEIGE	LED	10PZ.
FUS4146	7,5	MARRONE	LED	10PZ.
FUS4147	10	ROSSO	LED	10PZ.
FUS4148	15	BLU	LED	10PZ.
FUS4149	20	GIALLO	LED	10PZ.
FUS4150	25	BIANCO	LED	10PZ.
FUS4151	30	VERDE	LED	10PZ.



FUSIBILI LOW PROFILE CON PRESA DI CORRENTE

Marchio Guidoni.

CODICE	SEZIONE DEL CAVO	COLORE	PEZZI 
FUS 4154	10 AMPERE	ROSSO	5 PEZZI
FUS 4155	15 AMPERE	BLU	5 PEZZI
FUS 4156	20 AMPERE	GIALLO	5 PEZZI
FUS 4157	25 AMPERE	BIANCO	5 PEZZI
FUS 4158	30 AMPERE	VERDE	5 PEZZI



3- fusibili e portafusibili

KIT FUSIBILI LOW PROFILE



FUS4140

Dentro il box troverai **70** fusibili LOW PROFILE delle seguenti tipologie:

10 da 5 AMP,
10 da 7,5 AMP,
10 da 10 AMP,
15 da 15 AMP,
20 da 20 AMP,
25 da 25 AMP,
30 da 30 AMP,
Marchio Guidoni.

articoli correlati

FUS 4467
FUS 4468
FUS 4119

PORTAFUSIBILI ADD-A-CIRCUIT LOW PROFILE



FUS4141

2 pz. 

Portafusibili add-a-circuit con derivazione per fusibili low profile.

Marchio Guidoni.

articoli correlati

FUS 4140

FUSIBILI MIDI

Marchio Guidoni.

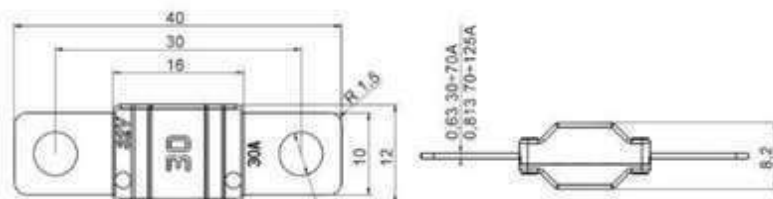

CODICE	AMPERE	COLORE	CF. 
FUS4412	30A	ARANCIO	10PZ.
FUS4410	40A	VERDE	10PZ.
FUS4407	50A	ROSSO	10PZ.
FUS4413	60A	GIALLO	10PZ.
FUS4408	80A	TRASPARENTE	10PZ.
FUS4414	70A	MARRONE	10PZ.
FUS4409	100A	BLU	10PZ.
FUS4411	125A	ROSA	10PZ.
FUS4415	150A	AZZURRO	10PZ.
FUS4416	200A	VIOLA	10PZ.



PORTAFUSIBILI MIDI



FUS4532 1 pz. 

Portafusibili serie midi
Marchio Guidoni.

articoli correlati

FUS 4335

FUS 4513



FUS4514 2 pz. 

Portafusibili per fusibili midi,
Marchio Guidoni.



FUS4515 1 pz. 

Kit portamidi fusibile tenuta stagna per cavo >25MMQ
portata ,massima 150AMP con staffa di fissaggio a parete
completo di terminali e 3 fusibili



FUS4548 1 pz. 

Scatola portafusibili 4 midi + 1 mega,
Marchio Guidoni.



FUS4548-1 1 pz. 

Scatola portafusibili 7 midi +1mega



FUS4562 1 pz. 

Morsetto con portamidi fusibili 2 vie

3- fusibili e portafusibili

FUSIBILI MEGA

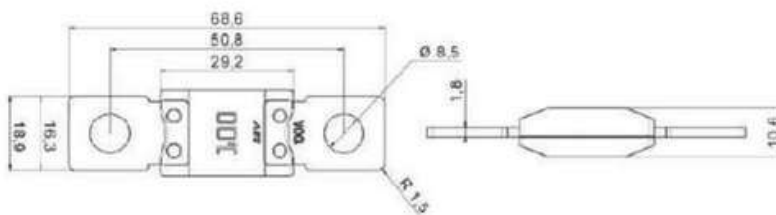

CODICE	AMPERE	COLORE	CF. 
FUS4388	40A	NERO	2 PZ.
FUS4389	60A	NERO	2 PZ.
FUS4390	80A	NERO	2 PZ.
FUS4400	100A	GIALLO	2 PZ.
FUS4401	125A	VERDE	2 PZ.
FUS4402	150A	ARANCIONE	2 PZ.
FUS4403	175A	BIANCO	2 PZ.
FUS4404	200A	BLU	2 PZ.
FUS4405	225A	BEIGE	2 PZ.
FUS4406	250A	ROSA	2 PZ.
FUS4397	300A	GRIGIO	2 PZ.
FUS4398	400A	VIOLA	2 PZ.
FUS4399	500A	MARRONE	2 PZ.

FUSIBILI MEGA TERMICI "CAL"

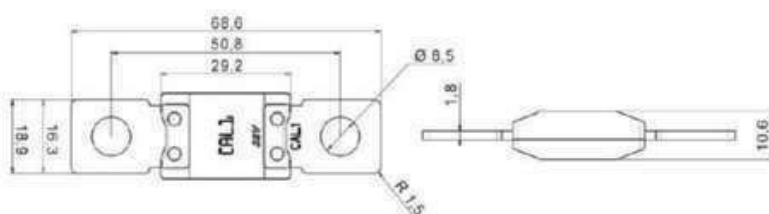

CODICE	CAL	COLORE	CF. 
FUS4391	CAL 1	GRIGIO	2 PZ.
FUS4392	CAL 2	NERO	2 PZ.
FUS4393	CAL 3	ROSSO	2 PZ.
FUS4394	CAL 4	MARRONE	2 PZ.
FUS4395	CAL 5	BEIGE	2 PZ.



PORTAFUSIBILI MEGA



FUS4509 2 pz.

Portafusibili componibili serie mega.

articoli correlati

FUS4534
TER1371
TER1372



FUS4539 1 pz.

Portafusibili per fusibili mega.

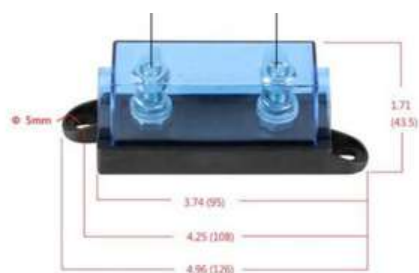

FUS4560 1 pz.

Porta mega fusibile con coperchio e alloggiamento per fusibile di scorta viti M8

temperatura di lavoro-40°+125*

da 40AMP->300AMP

massimo voltaggio in continuo 300AMP



FUS4561 1 pz.

Porta mega fusibile componibile tappo rosso in silicone VITI M8

temperatura di lavoro -40°+105*

DA 40AMP- >500AMP

serraggio raccomandato 25mm minimo

KIT PORTAFUSIBILI MEGA



FUS4528 1 pz.

Kit portafusibili con morsetto batteria serie mega tipo occhielli 1 via.

articoli correlati:

FUS4509
FUS4531
FUS4536



FUS4534 1 pz.

Portafusibili componibili serie mega marchio littlefuse.

articoli correlati

FUS 4531
FUS 4509
FUS 4528



KIT PORTAFUSIBILI MIDI-MEGA



FUS4531 1 pz.

Kit portafusibili serie midi-mega.

articoli correlati

FUS4528

FUS4536

FUS4536 1 pz.



Kit portafusibili elettrici serie midi-mega, 4 vie, specifico per IVECO DAILY, e FIAT DUCATO. include un portafusibile, 2 gommini passacavo, 2 terminali ed un coperchio rigido.

articoli correlati

FUS4509

FUS4528

FUS4531

PORTAFUSIBILI TRAZIONE 80V

FUS4450 1 pz.



Portafusibili serie trazione 80v tipo in ceramica 1 via, Marchio omega.

articoli correlati

FUS4423

FUSIBILI TRAZIONE 80V CON CERAMICA

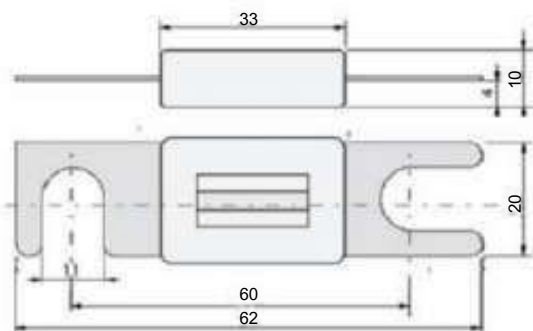

CODICE	AMPERE	CF.
FUS4420	20A	2 PZ.
FUS4421	25A	2 PZ.
FUS4422	35A	2 PZ.
FUS4423	40A	2 PZ.
FUS4424	50A	2 PZ.
FUS4425	63A	2 PZ.
FUS4426	80A	2 PZ.
FUS4427	100A	2 PZ.
FUS4428	125A	2 PZ.
FUS4429	160A	2 PZ.
FUS4430	175A	2 PZ.
FUS4431	200A	2 PZ.
FUS4432	225A	2 PZ.
FUS4433	250A	2 PZ.
FUS4434	275A	2 PZ.
FUS4435	300A	2 PZ.
FUS4436	325A	2 PZ.
FUS4437	355A	2 PZ.
FUS4438	400A	2 PZ.
FUS4439	425A	2 PZ.
FUS4440	500A	2 PZ.

3- fusibili e portafusibili

FUSIBILI IN CERAMICA 58V

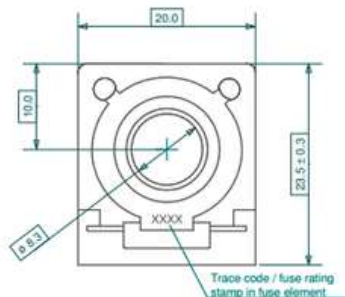

CODICE	AMPERE	CF.
FUS4480	30A	2 PZ.
FUS4481	40A	2 PZ.
FUS4482	50A	2 PZ.
FUS4483	60A	2 PZ.
FUS4484	75A	2 PZ.
FUS4485	80A	2 PZ.
FUS4486	100A	2 PZ.
FUS4487	125A	2 PZ.
FUS4488	150A	2 PZ.
FUS4489	175A	2 PZ.
FUS4490	200A	2 PZ.
FUS4491	250A	2 PZ.
FUS4492	300A	2 PZ.

FUSIBILI A NASTRO CON FORCELLA

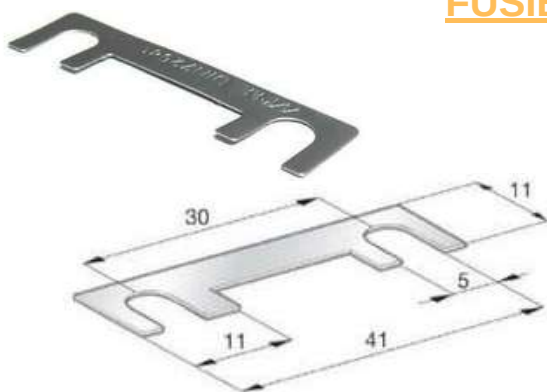

CODICE	AMPERE	CF.
FUS4326	40A	50PZ.
FUS4327	50A	50PZ.
FUS4328	60A	50PZ.
FUS4329	80A	50PZ.

FUSIBILI A NASTRO CON OCCHIELLI

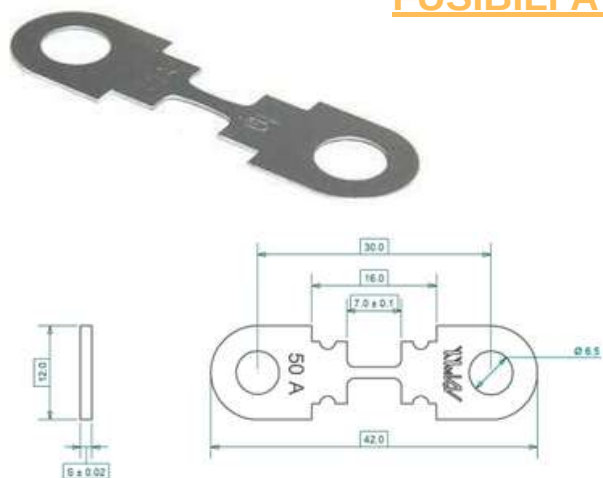

CODICE	AMPERE	CF.
FUS4330	30A	25PZ.
FUS4331	40A	25PZ.
FUS4332	50A	25PZ.
FUS4333	60A	25PZ.
FUS4335	80A	25PZ.
FUS4336	110A	25PZ.
FUS4338	150A	25PZ.
FUS4339	175A	25PZ.

PORTAFUSIBILI A NASTRO



FUS4513

5pz

Portafusibili serie a nastro e midi tipo con occhielli 1 via, Marchio mta.

articoli correlati

FUS4335
FUS4532
FUS4329



3- fusibili e portafusibili

FUSIBILI IN VETRO 5 X 20

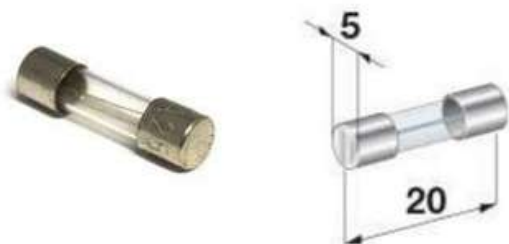

CODICE	AMPERE	CF. 
FUS4305	1 A	50PZ.
FUS4306	2 A	50PZ.
FUS4307	3 A	50PZ.
FUS4308	4 A	50PZ.
FUS4309	5 A	50PZ.
FUS4310	6 A	50PZ.
FUS4311	8 A	50PZ.
FUS4312	9 A	50PZ.
FUS4313	10 A	50PZ.
FUS4314	15 A	50PZ.
FUS4315	20 A	50PZ.

FUSIBILI IN VETRO 6,3 X 32

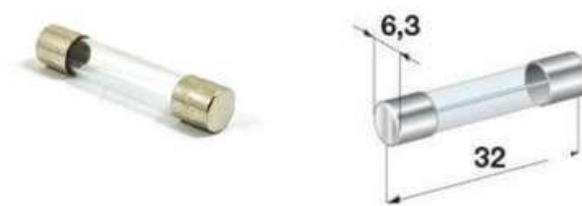

CODICE	AMPERE	CF. 
FUS4316	2 A	50PZ.
FUS4317	3 A	50PZ.
FUS4318	5 A	50PZ.
FUS4319	10 A	50PZ.
FUS4320	16 A	50PZ.
FUS4321	20 A	50PZ.
FUS4322	25 A	50PZ.
FUS4324	7,5 A	50PZ.
FUS4325	30 A	50PZ.



FUS4525

25pz. 

Portafusibili per fusibili vetro serie 5x20mm

Marchio Guidoni.

articoli correlati
FUS4307

FUSIBILI VECCHIO TIPO CILINDRICI



CODICE	AMPERE	COLORE	CF. 
FUS4300	8A	NERO	100PZ.
FUS4301	16A	VERDE	100PZ.
FUS4302	25A	MARRONE	100PZ.
FUS4303	40A	ROSSO	100PZ.

PORTAFUSIBILI CILINDRICI



FUS4503

10pz. 

Portafusibili serie cilindrici tipo in bachelite 1 via,

Marchio Guidoni.

articoli correlati
FUS4501
FUS4300



FUSIBILI SERIE JCASE

misure: 14 x 12 x 27,2 mm

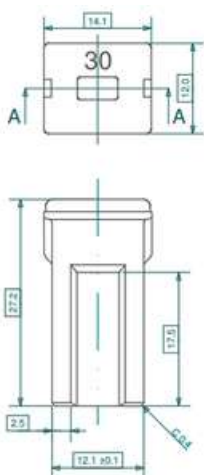

CODICE	AMPERE	COLORE	CF.
FUS4240	20A	AZZURRO	2 PZ.
FUS4241	30A	ROSA	2 PZ.
FUS4242	40A	VERDE	2 PZ.
FUS4243	50A	ROSSO	2 PZ.
FUS4244	60A	GIALLO	2 PZ.
FUS4245	70A	MARRONE	2 PZ.
FUS4246	80A	NERO	2 PZ.

FUSIBILI MINI JCASE

misure: 14,1 x 12 x 15,9 mm

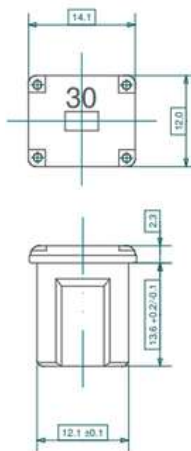

CODICE	AMPERE	COLORE	CF.
FUS4250	20A	AZZURRO	2 PZ.
FUS4251	25A	TRASPARENTE	2 PZ.
FUS4252	30A	ROSA	2 PZ.
FUS4253	40A	VERDE	2 PZ.
FUS4254	50A	ROSSO	2 PZ.
FUS4255	60A	GIALLO	2 PZ.

FUS4549

2 pz.

Portafusibile per fusibile jcase da FUS4240 A FUS4246 DA FUS4250 A FUS4255

Marchio Guidoni.



FUSIBILI MICRO JCASE

misure: 14,1 x 12 x 15,9 mm

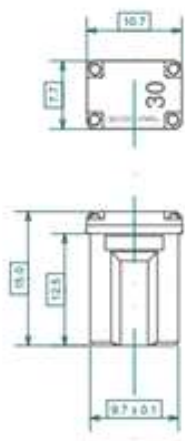

CODICE	AMPERE	COLORE	CF.
FUS4256	15A	GRIGIO	2 PZ.
FUS4257	20A	AZZURRO	2 PZ.
FUS4258	25A	TRASPARENTE	2 PZ.
FUS4259	30A	ROSA	2 PZ.
FUS4260	40A	VERDE	2 PZ.

3- fusibili e portafusibili

FUSIBILI SERIE AS

misure: 24,3 x 16 x 32,5 mm

CODICE	AMPERE	COLORE	CF. 
FUS4230	20A	AZZURRO	2 PZ.
FUS4231	30A	ROSA	2 PZ.
FUS4232	40A	VERDE	2 PZ.
FUS4234	50A	ROSSO	2 PZ.
FUS4235	60A	GIALLO	2 PZ.
FUS4236	80A	NERO	2 PZ.
FUS4237	100A	BLU	2 PZ.

FUSIBILI SERIE D

CODICE	AMPERE	COLORE	CF. 
FUS4203	25A	MARRONE	2 PZ.
FUS4204	30A	VERDE	2 PZ.

FUSIBILI SERIE E

misure: 23 x 15,9 x 38,8mm

CODICE	AMPERE	COLORE	CF. 
FUS4205	45A	ROSSO	2 PZ.
FUS4206	65A	NERO	2 PZ.
FUS4207	75A	GRIGIO	2 PZ.

FUSIBILI SERIE JM

misure: 10,7 x 7,7 x 17,5mm

CODICE	AMPERE	COLORE	CF. 
FUS4262	15A	OCRA	2 PZ.
FUS4263	20A	AZZURRO	2 PZ.
FUS4264	25A	GIALLO	2 PZ.
FUS4265	30A	ROSA	2 PZ.
FUS4266	40A	VERDE	2 PZ.
FUS4267	50A	ROSSO	2 PZ.

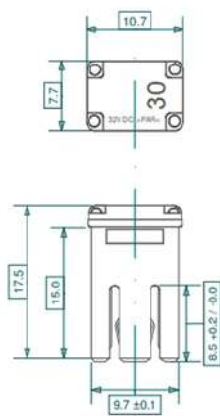
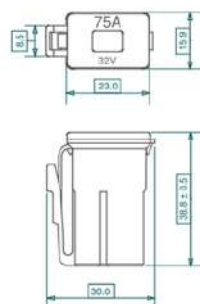
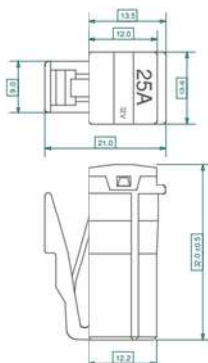
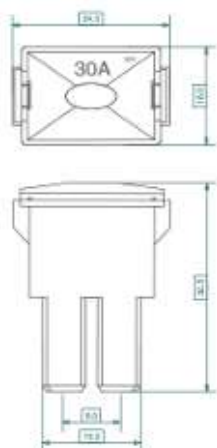
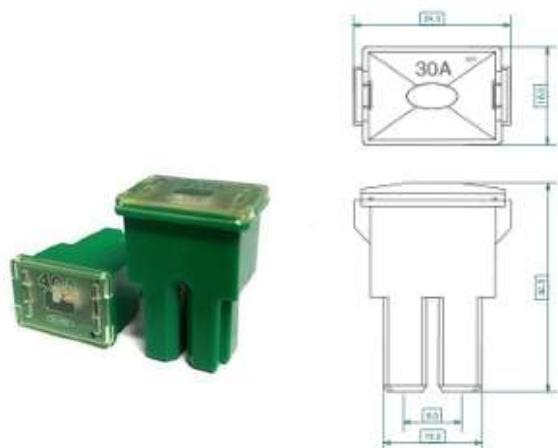

3- fusibili e portafusibili

FUSIBILI SERIE B MASCHIO

misure: 22,2 x 15,2 x 24,5 (+20,5) mm

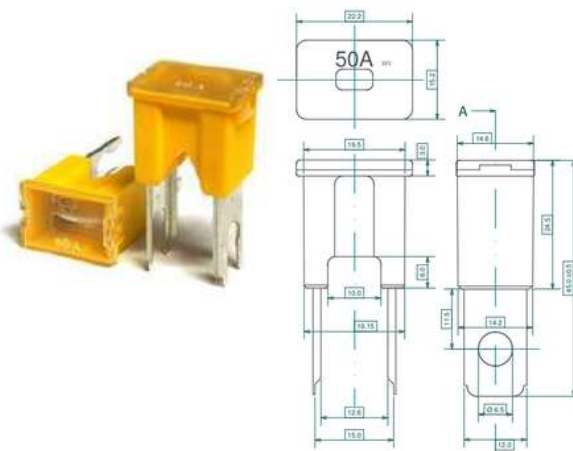

CODICE	AMPERE	COLORE	CF. 
FUS4210	30A	ROSA	2 PZ.
FUS4211	40A	VERDE	2 PZ.
FUS4212	50A	ROSSO	2 PZ.
FUS4213	60A	GIALLO	2 PZ.
FUS4214	80A	NERO	2 PZ.
FUS4215	100A	BLU	2 PZ.
FUS4216	120A	TRASPARENTE	2 PZ.
FUS4217	140A	ROSSO MATTONE	2 PZ.

FUSIBILI SERIE C MASCHIO

misure: 22 (+40) x 15,2 x 22,2 mm

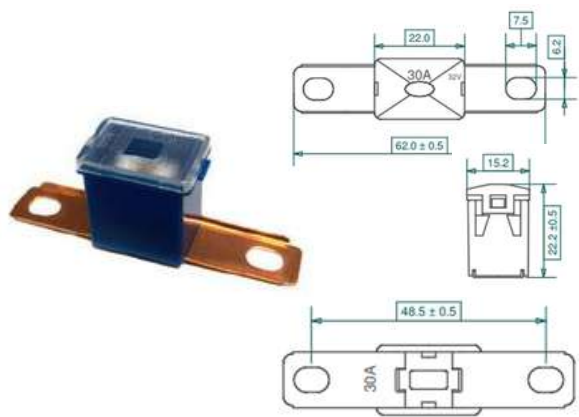

CODICE	AMPERE	COLORE	CF. 
FUS4220	30A	ROSA	2 PZ.
FUS4221	40A	VERDE	2 PZ.
FUS4222	50A	ROSSO	2 PZ.
FUS4223	60A	GIALLO	2 PZ.
FUS4224	80A	NERO	2 PZ.
FUS4225	100A	BLU	2 PZ.

FUSIBILI MERCEDES

FUS4451 1 pz. 

Fusibile 6 vie mercedes 5 ampere.

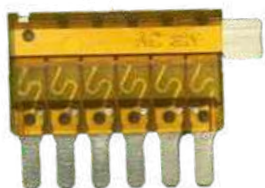

FUS4452 1 pz. 

Fusibile 6 vie mercedes 7,5 ampere.



APPLICAZIONI

MB MODEL	MB TYPE	YEAR
ML	W166	>2010
GLE	W167	>2018
C	W205	>2014
E	W213	>2016
S	W222	>2013
E-COUPE	W238	>2016
GLC	W253	>2015
G	W463	>2012
SPRINTER	W907	>2014



FUSIBILI DI POTENZA RIPRISTINABILI

Marchio Guidoni.



CODICE	AMPERE	CF 
FUS4270	50A	1 PZ.
FUS4271	70A	1 PZ.
FUS4272	80A	1 PZ.
FUS4273	100A	1 PZ.
FUS4274	120A	1 PZ.
FUS4275	150A	1 PZ.
FUS4276	200A	1 PZ.
FUS4278	300A	1 PZ.

MODULI FRAMES



FUS4600 1 pz. 

Coperchi per moduli frames 4 vie.

articoli correlati

FUS4601
FUS4608
FUS4609



FUS4601 1 pz. 

Moduli frames (corpo) tipo b 4 vie.

articoli correlati

FUS4600
FUS4608
FUS4609

MODULI FRAMES TIPO A



FUS4603 1 pz. 

Coperchi tipo a per moduli frames 5 vie.

articoli correlati

FUS4602
FUS4606
FUS4607



FUS4602 1 pz. 

Moduli frames (corpo) tipo a 5 vie.

articoli correlati

FUS4603
FUS4606
FUS4607



MODULI FRAMES



FUS4608 1 pz.

Moduli frames per portarele' 2 vie.

articoli correlati

TER1383

FUS4605 1 pz.

Moduli frames per portafusibili maxi 6 vie.

articoli correlati

TER1327

TER1329

FUS4607 1 pz.

Moduli frames per portafusibili mini e maxi rele' 10+1 vie.

articoli correlati

TER1381

TER1386

TER1324

TER1353

FUS4604 1 pz.

Moduli portaminival 20 vie.

articoli correlati

TER1381

TER1386

FUS4609 1 pz.

Moduli frames per micro-rele' 6 vie.

articoli correlati

TER1383

TER1382



FUS4606

1 pz.

Moduli frames per porta-rele' e mini-portarele'
maxi 1+1 vie
Marchio mta

articoli correlati

TER1353
TER1383

STAFFE E COPERCHI



FUS4611

1 pz.

Coperchi per moduli frames 1 via,
Marchio mta.

articoli correlati

FUS4610



FUS4610

2 pz.

Staffa di fissaggio per moduli frames 1 via,
Marchio mta.

articoli correlati

FUS4611



FUS4613

1 pz.

Coperchi per moduli frames 2 vie,
Marchio mta.

articoli correlati

FUS4612



FUS4612

2 pz.

Staffe per moduli frames 2 vie,
Marchio mta.

articoli correlati

FUS4613

