



**MATERIALI E COMPONENTI ELETTRICI  
PER AUTOMOTIVE E INDUSTRIA**



CATALOGO ILLUMINAZIONE  
**2026 - 2027**

# LAMPADE

7

## LED, FARI E FANALI



### CAPITOLO 7

- Lampade LED e xenon
- Fari da lavoro LED
- Lampeggianti e multiflash LED
- Fari e fanali
- Barre lampeggianti LED
- Plafoniere LED

LAMPADE

FARI E FANALI

### LAMPADE XENON



CODICE	CARATTERISTICHE	ATTACCO	CF. 
FK120144	D1S 85V-35W	PK32D-2	1PZ.
FK126150	D1R 85V-35W	PK32D-3	1PZ.
FK120340	D3S 42V-35W	PK32D-5	1PZ.
FK126540	D5S 12V-25W	PK32D-2	1PZ.
FK126548	D8S 42V-25W	PK32D-1	1PZ.



CODICE	CARATTERISTICHE	ATTACCO	CF. 
FK120240	D2S 85V-35W	P32D-2	1PZ.
FK120250	D2R 85V-35W	P32D-3	1PZ.
FK120440	D4S 42V-35W	P32D-5	1PZ.
FK120450	D4R 42V-35W	P32D-6	1PZ.

### LAMPADE ALOGENE



CODICE	CARATTERISTICHE	ATTACCO	CF. 
FK120210	H7 12V-55W	PX26D	1PZ.
FK120180L	H18 12V-65W	PY26D-1	1PZ.
FK120181L	H19 12V-60/55W	PU43T	1PZ.
FK120215	H7 24V-70W	PX26D	1PZ.



CODICE	CARATTERISTICHE	ATTACCO	CF. 
FK120193	H4 12V-60/55W	P43T	1PZ.
FK240196	H4 24V-75/70W	P43T	1PZ.



**FK127951** 10 pz. 

Lampada asimmetrica 12V attacco P45T



## 7- Lampade LED e xenon



**FK127183**

10 pz.

Lampada H5 12V-60/55W attacco P45T



**FK120150**

10 pz.

Lampada H1 12V-55W attacco P14,5S



**FK120151**

10 pz.

Lampada H3 12V-55W attacco PK22S



CODICE	CARATTERISTICHE	ATTACCO	CF.
FK129005	HB3 12V-65W	9005-P20D	1PZ.
FK129006	HB4 12V-51W	9006-P22D	1PZ.
FK120212	H8 12V-35W	PGJ19-1	1PZ.
FK120213	H9 12V-65W	PGJ19-5	1PZ.
FK120145	H10 12V-42W	PY20D	1PZ.
FK120211	H11 12V-55W	PGJ19-2	1PZ.
FK120241	H11B 12V-55W	PGJ19-2	1PZ.
FK120055	H12 12V-53W	90055-PZ20D	1PZ.
FK120219	H16 12V-19W	PGJ19-3	1PZ.
FK120012	HIR2 12V-55W	9012-PX22D	1PZ.



CODICE	CARATTERISTICHE	ATTACCO	CF.
FK120008	H13 12V-60/55W	PJ26,4	1PZ.
FK120176	H15 12V-55/15W	PGJ23T-1	1PZ.
FK120881	H27/2 12V-27W	881-PGJ13	1PZ.



## COPPIE DI LAMPADE ALOGENE

**SUPER WHITE e +130%**



CODICE	CARATTERISTICHE	CF. 
FK12193CB	COPPIA DI LAMPADE H4 12V COOL BLUE KIT	2PZ.
FK12210CB	COPPIA DI LAMPADE H7 12V COOL BLUE KIT	2PZ.
FK12H4130	COPPIA DI LAMPADE H4 12V +130% DI LUCE	2PZ.
FK12H7130	COPPIA DI LAMPADE H7 12V +130% DI LUCE	2PZ.
FK24H4130	COPPIA DI LAMPADE H4 24V +130% DI LUCE	2PZ.
FK24H7130	COPPIA DI LAMPADE H7 24V +130% DI LUCE	2PZ.

## LAMPADE AUSILIARIE



CODICE	CARATTERISTICHE	CF. 
FK122721	LAMPADA 12V-1,2W VETRO T5	10PZ.
FK242741	LAMPADA 24V-5W VETRO T5	10PZ.



CODICE	CARATTERISTICHE	CF. 
FK122825	LAMPADA 12V-5W VETRO T10	10PZ.
FK242845	LAMPADA 24V-5W VETRO T10	10PZ.



CODICE	CARATTERISTICHE	CF. 
FK120921	LAMPADA 12V-16W VETRO T15	10PZ.
FK12921NA	LAMPADA 12V-16W VETRO T15 <b>ARANCIO</b>	10PZ.



CODICE	CARATTERISTICHE	CF. 
FK127505	LAMPADA 12V-21W VETRO T20	10PZ.
FK127515	LAMPADA 12V-21W/5W VETRO T20 <b>BILUCE</b>	10PZ.



## 7- Lampade LED e xenon



CODICE	CARATTERISTICHE	ATTACCO	CF.
FK127506	12V-21W	BA15S	10PZ.
FK127507	12V-21W ARANCIO	BAU15S	10PZ.
FK247511	24V-21W	BA15S	10PZ.
FK247510	24V-21W ARANCIO	BAU15S	10PZ.



CODICE	CARATTERISTICHE	ATTACCO	CF.
FK127528	12V-21W/5W	BAY15D	10PZ.
FK127225	12V-21W/4W	BAZ15D sfalsata	10PZ.
FK247537	24V-21W/5W	BAY15D	10PZ.



CODICE	CARATTERISTICHE	ATTACCO	CF.
FK125007	12V-5W SFERA	BA15S	10PZ.
FK125008	12V-10W SFERA	BA15S	10PZ.
FK245627	24V-5W SFERA	BA15S	10PZ.
FK245637	24V-10W SFERA	BA15S	10PZ.



CODICE	CARATTERISTICHE	ATTACCO	CF.
FK123893	12V-4W SPIA	BA9S	10PZ.
FK243930	24V-4W SPIA	BA9S	10PZ.



CODICE	CARATTERISTICHE	ATTACCO	CF.
FK126418	12V-5W SILURO	SV8,5 - 11X38	10PZ.
FK126438	12V-10W SILURO	SV8,5 - 10X31	10PZ.
FK246423	24V-5W SILURO	SV8,5 - 11X38	10PZ.
FK246429	24V-10W SILURO	SV8,5 - 11X38	10PZ.



**FK120132** 10 pz.

Lampada **H6** 12V 6W attacco BAX9S

**FK120136** 10 pz.

Lampada **H21** 12V 21W attacco BAY9S



## 7- Lampade LED e xenon



**FK12024W** 1 pz.

Lampade a incandescenza serie **PS24W**  
**12VOLT 24WATT**  
attacco **PG20/7** per peugeot



**FK12Y24W** 1 pz.

Lampade a incandescenza serie **PY24W**  
**12VOLT 24WATT** colore **arancio**  
attacco **PGU20/4** per BMW



**FK12019W** 1 pz.

Lampade a incandescenza serie **PS19W**  
**12VOLT 24WATT**  
attacco **PG20/1** per AUDI



**FK12X24W** 1 pz.

Lampade a incandescenza serie **PSx24W**  
**12VOLT 24WATT**  
attacco **PG20/7** per peugeot



**FK12K24W** 1 pz.

Lampade a incandescenza serie **PW24W**  
**12VOLT 24WATT**

### LAMPADE LED T5



**OSR9900** 2 pz.

Lampade led smd serie **T5 12V**, tutto vetro. **1,2WATT**  
bianche, attacco **w2x4,6d**.

### LAMPADE LED T10



**OSR9901/5OS** 2 pz.

Lampade LED **12V 5W** vetro **T10** bianca con  
chip osram cambus

Marchio Guidoni.



### WARNING CANCELLER PER LAMPADE LED



#### OSR9916 2 pz.

Resistenza led smd **12V** spegni spia, serie **T10**

Marchio Guidoni.



CODICE	VOLT	WATT	CF.
<b>OSR9908-1</b>	12V	5W	<b>1 COPPIA</b>
<b>OSR9909-1</b>	12V	21W	<b>1 COPPIA</b>
<b>OSR9910</b>	24V	5W	<b>1PZ.</b>
<b>OSR9911</b>	24V	21W	<b>1PZ.</b>



#### OSR9903 2 pz.

Resistenza led **12V-4W** colore **bianco** e attacco **ba9s**

Marchio Guidoni.



#### OSR9877 2 pz.

Lampada LED **bax9s** H6, **12/24V** canbus **12V**

#### OSR9876 2 pz.

Lampada LED **baY9s** H21, **12/24V** canbus **12V**

Marchio Guidoni

### LAMPADE ATTACCO BA15D



#### OSR9906 2 pz.

Lampade LED **12V** , bianche, attacco **ba15s**

Marchio Guidoni.

#### OSR9907 2 pz.

Lampade LED **12V**, attacco **ba15d**

Marchio Guidoni.

### LAMPADE ATTACCO BA15S



#### OSR9905 2 pz.

Lampade LED **12V-5W**, bianche a sfera con attacco **ba15s**

Marchio Guidoni.

### LAMPADE LED SILURO

Lampade canbus siluro a 6LED smd **12-24VOLT 4,5WATT**, attacco **sv8**, bianche, per auto e camion.

Marchio Guidoni.



CODICE	ATTACCO	VOLT	WATT	LUNGHEZZA	CF. 
OSR9873	SV8	12-24V	4,5W	31MM	2PZ.
OSR9874	SV8	12-24V	4,5W	36MM	2PZ.
OSR9984	SV8	12-24V	4,5W	39MM	2PZ.
OSR9875	SV8	12-24V	4,5W	41MM	2PZ.

### LAMPADE LED HIGH POWER

Lampade LED **12-24V**, colore bianco high power con attacco **ba15s**.



CODICE	ATTACCO	VOLT	WATT	COLORE	CF. 
OSR9882	BA15S	12-24V	16W	BIANCO	2PZ.
OSR9883	BA15S	12-24V	16W	ARANCIO	2PZ.



**OSR9884** 2 pz. 

Lampade led **12-24volt 16W**, colore bianco high power biluce con attacco **ba15d**

Marchio Guidoni.

### LAMPADE LED HIGH POWER FULLCANBUS



**OSR9700LLV** 2 pz. 

Lampada LED **T20 12V**  
 - canbus W3X16D 200-7515 colore **bianco**  
 - monoluce con ventola di raffreddamento e lente



**OSR9701LLV** 2 pz. 

Lampada LED **T20 12V**  
 - canbus W3X16D  
 200-7505 colore **bianco**  
 - biluce con ventola di raffreddamento e lente



**OSR9888** 2 pz. 

Lampada LED **BAU15S 12/24V**  
 - canbus colore **arancio**  
 - con ventola di raffreddamento e lente

## 7- Lampade LED e xenon



**ELE5305**

2 pz.

Intermittenza **12V** specifica per lampade a LED con battito freccia regolabile per vetture europee.

### LAMPADE LED T15 TUTTO VETRO



**OSR9703L**

2 pz.

Lampade LED **T15** tutto vetro - 921 **12-24V** 11w, colore **bianco**

### LAMPADE LED T20 MONOLUCE E BILUCE

Dettagli articoli:

Lampade LED serie **T20 12V/21W** W3x16d 200-7505 da **12-24V** e 11W, **Monoluce**.



CODICE	SERIE	VOLT	WATT	COLORE	CF.
OSR9700L	T20	12-24V	11W	BIANCO	2PZ.
OSR9704L	T20	12-24V	11W	ARANCIO	2PZ.

Dettagli articoli:

Lampade LED serie **21/5W** w3x16d 200-7515 da **12-24V** e **11watt**, **Biluce**.



CODICE	SERIE	VOLT	WATT	COLORE	CF.
OSR9701L	T20	12-24V	11W	BIANCO	2PZ.
OSR9701LA	T20	12-24V	11W	ARANCIO	2PZ.

### LAMPADE LED W2.5X16Q MONOLUCE E BILUCE

Dettagli articoli:

Lampade led serie w2,5x16q da 12-24volt e 11 watt, **biluce**. Facile installazione e massima qualità.

Marchio Guidoni.



CODICE	SERIE	VOLT	WATT	COLORE	CF.
OSR9706L	W2,5X16Q	12-24V	11W	BIANCO	2PZ.
OSR9707L	W2,5X16Q	12-24V	11W	ARANCIO	2PZ.

Dettagli articoli:

Lampade led serie w2,5x16d da 12-24volt e 11 watt, **monoluce**. Facile installazione e massima qualità.

Marchio Guidoni.



CODICE	SERIE	VOLT	WATT	COLORE	CF.
OSR9708L	W2,5X16D	12-24V	11W	BIANCO	2PZ.
OSR9709L	W2,5X16D	12-24V	11W	ARANCIO	2PZ.



### LAMPADE LED SMD PER CRUSCOTTO



**OSR9000L** 2 pz.

Lampada LED 12v 1.2W 2721 mf8



**OSR9001L** 2 pz.

Lampada LED 12V 1.2W 2721 mf



CODICE	VOLT	DIAMETRO	CF.
OSR9760	12V	8mm	2PZ.
OSR9761	12V	10mm	2PZ.
OSR9762	12V	12mm	2PZ.

### LAMPADE LED 24V



**OSR9930** 2 pz.

Lampade LED smd serie **T5, 24V** tutto vetro, **bianche**



**OSR9920** 2 pz.

lampada a led **24V-5W**, vetro, T10 **bianche**



**OSR9925** 2 pz.

Lampade led smd **24V, bianche** attacco BA9S



**OSR9922** 2 pz.

Lampade led smd serie **24V, bianche** attacco **BA15S** sostituisce **24V/5W sfera BA15S**



**OSR9923** 2 pz.

Lampade LED smd serie **12/24V bianche** attacco **BA15S** sostituisce **BA15S 24V/12W**



**OSR9929** 2 pz.

Lampade LED **BAY15D** sostituisce **BAY15D 24V-21W/5W** biluce

### KIT LED CANBUS TOP QUALITY



10000 lumen per  
lampada  
12-24V

dettagli articoli:

KIT lampade LED canbus MOD.F3 con ventola

CODICE	DESCRIZIONE	VOLT/WATT	LUMEN
OSR9830	H7	12/24V- 45W	10000
OSR9831	H4	12/24V- 45W	10000
OSR9832	H8	12/24V- 45W	10000
OSR9833	H10	12/24V- 45W	10000
OSR9834	H11	12/24V- 45W	10000
OSR9835	HB3	12/24V- 45W	10000
OSR9836	HB4	12/24V- 45W	10000
OSR9837	HIR2	12/24V- 45W	10000

### KIT LED CANBUS



dettagli articoli:

KIT LED high power canbus

12/24V

CODICE	DESCRIZIONE	VOLT/WATT	LUMEN
OSR9985-1	H7	12/24V- 60W	12000
OSR9985-2	H4	12/24V- 60W	12000
OSR9985-3	H1	12/24V- 60W	12000
OSR9985-4	H8 e H11	12/24V- 60W	12000



### KIT LED PLUG AND PLAY



dettagli articoli:

KIT lampade LED **con ventola di raffreddamento**

**40000 lumen per  
lampada  
12V**

CODICE	DESCRIZIONE	VOLT/WATT	LUMEN
OSR9821	H7	12V- 30W	40000
OSR9822	H4	12V- 30W	40000
OSR9815	HB4	12V- 30W	40000
OSR9816	HB3	12V- 30W	40000
OSR9817	H11	12V- 30W	40000
OSR9818	H3	12V- 30W	40000
OSR9819	H1	12V- 30W	40000

### KIT LED SPECIFICI PER FARI LENTICOLARI



<b>OSR9981-1</b>	<b>OSR9981-2</b>	<b>OSR9981-3</b> 1 pz.
Kit lampade LED <b>H7</b>	Kit lampade LED <b>HB3 - HB4 - H10</b>	Kit lampade LED <b>H8 - H11</b>

dettagli articoli

Premium cambus **12/24V - 6.000 LUMEN** per Lampada

### COPPIA CENTRALINE SUPER CANBUS per tutti i KIT LED



**OSR9980-11** 1 pz.

**COPPIA SUPER CANBUS H7** NO FLASH - WARNING CANCELLER



**OSR9980-12** 1 pz.

**COPPIA SUPER CANBUS H4** NO FLASH - WARNING CANCELLER



**OSR9980-13** 1 pz.

**COPPIA SUPER CANBUS H1 - H3** NO FLASH-WARNING CANCELLER



















## KIT ADATTATORI PER LAMPADRE LED



### OSR9995/20

1 pz. 

Kit adattatori lampade LED  
Marchio Guidoni.

<p><b>OSR 9995/1</b> Coppia adattatori per kit lampade LED H7, Universale. Foro 22mm Audi A3, A4L, BMW Serie S, X5, Buick Regal, Execlis, Lacross, Mercedes Classe E, ML, Nissan Qashqai, Opel Astra, Renault Master, W New Boro</p> 	<p><b>OSR 9995/2</b> Coppia adattatori per kit lampade LED H7 Foro 22mm AUDI, BMW, Mercedes, Classe B,C, GLA, GL</p> 	<p><b>OSR 9995/3</b> Coppia adattatori per kit lampade LED H7, Foro 23 mm Citroen C5, DS4, DS6, Ford Mondeo, Peugeot 508,2008,3008</p> 	<p><b>OSR 9995/4</b> Coppia adattatori per kit lampade LED H7, Anabbagliante, Foro 24mm Ford Focus, Mondeo, Fiesta</p> 	<p><b>OSR 9995/5</b> Coppia adattatori per kit lampade LED H1, Anabbagliante Ford Focus</p> 	<p><b>OSR 9995/6</b> Coppia adattatori per kit lampade LED H7 Hyundai Santa Fe, Qashqai, New Tucson Sonata</p> 
<p><b>OSR 9995/7</b> Coppia adattatori per kit lampade LED H Hyundai Mistra, Kia New Carens</p> 	<p><b>OSR 9995/8</b> Coppia adattatori per kit lampade LED H VW Polo, New Tiguan, Skoda Octavia, MG, GS</p> 	<p><b>OSR 9995/9</b> Coppia adattatori per kit lampade LED H7, Foro 22mm Mercedes Sprinter, Seat Alhambra 2012, W Golf IV, VII, Scirocco</p> 	<p><b>OSR 9995/10</b> Coppia adattatori per kit lampade LED H1, Universale, Foro 22mm DongFeng, Fengxing Honda, Odyssey, Cielly, Moto G Eagle, SouthEast, V3 V4 V6</p> 	<p><b>OSR 9995/11</b> Coppia adattatori per kit lampade LED H7, Mazda 3, Outlander</p> 	<p><b>OSR 9995/12</b> Coppia adattatori per kit lampade LED H Foro 23mm Alfa Romeo Mito, Audi A6, Ford Kuga, Renault Megane 4, VW Sagitar, Passat 3G, Touran</p> 
<p><b>OSR 9995/13</b> Coppia adattatori per kit lampade LED H7, Anabbagliante W Tiguan, Golf VII, Scirocco, Sharon, Multivan</p> 	<p><b>OSR 9995/14</b> Coppia adattatori per kit lampade LED H7, Autoalimentazione con spina, Foro 23mm Mercedes Sprinter, Seat A1, Hembra 2012, VW Golf, VII, Sharon, Touran Scirocco, Polo 2013</p> 	<p><b>OSR 9995/15</b> Coppia adattatori per kit lampade LED H1, Abbagliante Ford Focus, Mondeo, Fiesta</p> 	<p><b>OSR 9995/16</b> Coppia adattatori per kit lampade LED H7 Fiat Nuova 500 500X, 500L</p> 		

### OSR9995/1

1 pz. 

Coppia adattatori per kit lampade LED **H7**, universale, foro 22mm audi a3, a4l, a6l, bmw serie5, x5, mercedes classe e, ml, nissan qashqai, opel astra, renault master, vw new bora



Marchio Guidoni.

### OSR9995/2

1 pz. 

Coppia adattatori per kit lampade LED **H7**, foro 22mm, audi, bmw, mercedes classe b, c, gla, gl

Marchio Guidoni.





### OSR9995/3 1 pz.

Coppia adattatori per kit lampade LED **H7**, foro 23 mm, citroen c5, ds5, ds6, ford mondeo, peugeot 508, 2008, 3008

Marchio Guidoni.



### OSR9995/4 1 pz.

Coppia adattatori per kit lampade LED **H7**, anabbagliante foro 24mm, ford focus mondeo, fiesta.

Marchio Guidoni.



### OSR9995/5 1 pz.

Coppia adattatori per kit lampade LED **H1**, anabbagliante ford focus.

Marchio Guidoni.



### OSR9995/6 1 pz.

Coppia adattatori per kit lampade LED **H7**, hyundai santa fe, qashqai, new tucson, sonata.

Marchio Guidoni.



### OSR9995/7 1 pz.

Coppia adattatori per kit lampade LED **H7**, universale, hunday, kia, new carens

Marchio Guidoni.



### OSR9995/8 1 pz.

Coppia adattatori per kit lampade LED **H7**, vw polo, new tigan, skoda octavia, mg gs

Marchio Guidoni.





### OSR9995/9 1 pz.

Coppia adattatori per kit lampade LED **H7**, foro 22mm  
mercedes sprinter, seat alhambra 2012

Marchio Guidoni.



### OSR9995/10 1 pz.

Coppia adattatori per kit lampade LED **H1**, foro 19mm

Marchio Guidoni.



### OSR9995/11 1 pz.

Coppia adattatori per kit lampade LED **H7** mazda 3, outlander

Marchio Guidoni.



### OSR9995/12 1 pz.

Coppia adattatori per kit lampade LED **H7**, foro 23mm  
alfa romeo mito, audi a6, ford Kuga, renauld MEGANE 4,  
vw agitar, passat 3c, touran

Marchio Guidoni.



### OSR9995/13 1 pz.

Coppia adattatori per kit lampade LED **H7**, anabbagliante  
vw tiguan, golf VII, scirocco, multivan

Marchio Guidoni.



### OSR9995/14 1 pz.

Coppia adattatori per kit lampade LED **H7**, auto-alimentazione  
con spina, foro 23mm mercedes Sprinter, seat a1, alhambra  
2012, vw golf, vii, sharAn, touran, scirocco, polo 2013

Marchio Guidoni.



## 7- Lampade LED e xenon



### OSR9995/15

1 pz.

Coppia adattatori per kit lampade LED **H1**, abbaglianti  
ford focus mondeo, fiesta

Marchio Guidoni.



### OSR9995/16

1 pz.

Coppia adattatori per kit lampade LED **H7**,  
fiat nuova 500, 500x, 500i

Marchio Guidoni.



### OSR9995/17

1 pz.

Coppia adattatori lampade kit led e xenon per trasformazione  
da **h4** a **h5**

Marchio Guidoni.

## COPPIA DI TAPPI IN GOMMA PER KIT



CODICE	DIAMETRO	CF.
OSR9991/1	55mm	2PZ.
OSR9991/2	65mm	2PZ.
OSR9991/3	70mm	2PZ.
OSR9991/4	80mm	2PZ.
OSR9991/5	85mm	2PZ.
OSR9991/6	90mm	2PZ.
OSR9991/7	95mm	2PZ.
OSR9991/8	100mm	2PZ.
OSR9991/9	105mm	2PZ.
OSR9991/10	110mm	2PZ.
OSR9991/11	115mm	2PZ.
OSR9991/12	120mm	2PZ.

## MOLLETTE DI RITENUTA PER LE LAMPADE



OSR9800-1	H1-1		OSR9802-3	H4-3	
OSR9800-2	H1-2		OSR9803-1	H7-1	
OSR9800-3	H1-3		OSR9803-2	H7-2	
OSR9800-4	H1-4		OSR9803-3	H7-3	
OSR9801	H3		OSR9804	UNIVERSALI SINGOLE	
OSR9802-2	H4-2		OSR9805	UNIVERSALI DOPPIE	

### KIT

#### OSR9806

Kit **12 COPPIE** MOLLETTE DI RITENUTA PER LAMPADE



## FARI DA LAVORO LED HIGH POWER

### IND8200 1 pz.

Faro LED **63W+10W 12/24V** 9 LED da 7W CREE **100X92X69MM** connettore deutsch

3 funzioni  
faro lavoro- luce diurna - luce arancio

6000K IP67-IP69K  
Temperatura di lavoro -40°+85°  
EMARK



### IND8201 1 pz.

Faro LED **60W+10W 12/24V** 6 LED da 10W CREE **245X139.5X91.35MM** connettore deutsch

3 funzioni  
faro lavoro- luce diurna - luce arancio

6000K IP67  
Temperatura di lavoro -40°+85°

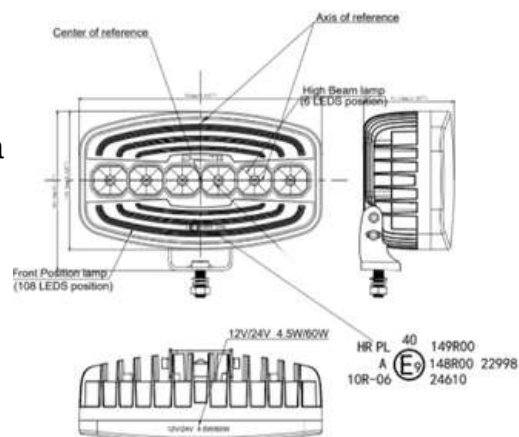

### IND8202 1 pz.

Faro LED **80W+10W 12/24V** 8 LED da 7W CREE **155X177X93MM** connettore deutsch

3 funzioni  
faro lavoro- luce diurna - luce arancio

6000K IP67-IP69K  
Temperatura di lavoro -40°+85°

EMARK

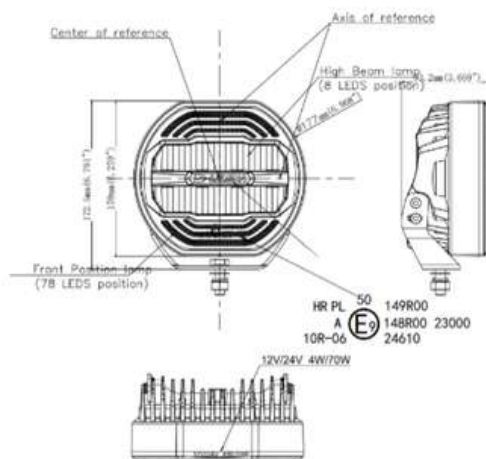

### IND8203 1 pz.

Faro LED **160W+10W 12/24V** 8 LED da 20W CREE **204X227X110** connettore deutsch

3 funzioni  
faro lavoro- luce diurna - luce arancio

6000K IP67  
Temperatura di lavoro -40°+85°

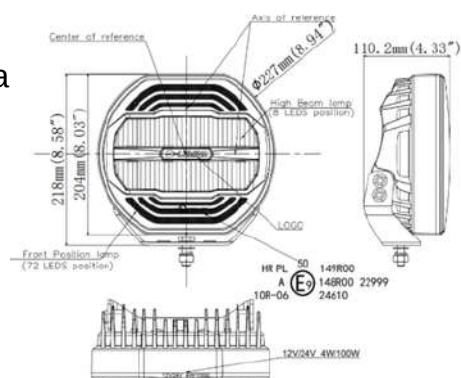

## 7- Fari da lavoro LED



6000K IP67  
Temperatura di lavoro  
-40+85 ECE R10  
connettore deutsch

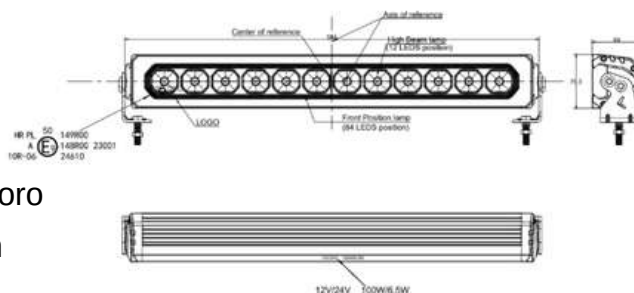

[dettagli articoli](#)

12/24V

CODICE	FUNZIONI	WATT	LUMEN	MISURE	CF.
IND8204	FARO LAVORO, LUCE DIURNA, LUCE	140W	950 LM	584X76X69mm	1PZ.
IND8204-1	FARO LAVORO, LUCE DIURNA, LUCE	220W	15000 LM	813X76X69mm	1PZ.
IND8204-2	FARO LAVORO, LUCE DIURNA, LUCE	280W	18000 LM	1067X76X69mm	1PZ.



**IND8264**

1 pz.



**CHIP & LED  
OSRAM**

Faro lavoro 4 led forma quadrata **12/24V** - 1500 lumen  
misure: 7.62 X7.62 CM  
IP6K9K

In rapporto alle dimensioni, il più piccolo e potente faro sul mercato.



**IND8265**

1 pz.



**CHIP & LED  
OSRAM**

Faro lavoro 4 LED forma tonda **12/24V**  
diametro: 7.62 CM - 1500 lumen- IP6K9K

In rapporto alle dimensioni, il più piccolo e potente faro sul mercato.



**IND8267**

1 pz.



**CHIP & LED  
OSRAM**

Faro lavoro 6 led forma quadrata **12/24V** -  
**2350 lumen 30W**  
misure: 9X9CM  
IP6K9K



## 7- Fari da lavoro LED



**IND8268**

1 pz. 



**CHIP & LED  
OSRAM**

Faro lavoro 6 led forma tonda **12/24V** -  
2350 lumen **30W**

**misure:** D. 10,2cm

IP6K9K



**IND8269**

1 pz. 



**CHIP & LED  
OSRAM**

Faro lavoro 16 led forma quadrata **12/24V** - 2350  
lumen **48W**

**misure:** 8.4X8.4X3.3CM

IP6K9K

**IND8212**

1 pz. 



Faro da lavoro forma tonda 6 LED osram da 10W  
**12/24V** 5100 LUMEN

Diametro: 130mm

Profondità: 81mm

**applicazioni:**

Allis 7069614

case A145495

International 131368C92

John deere: RE19079-AR8560



**CHIP & LED  
OSRAM**



**IND8213**

1 pz. 



**CHIP & LED  
OSRAM**

Faro da lavoro 4 LED osram 40W **12/24V**  
3200 LUMEN

**misure:** 84x84x33mm

IP6K9K



**IND8208**

1 pz. 

Faro da lavoro forma quadrata 9 led

**9-32V 27W**

1755 LUMEN

Marchio Guidoni.

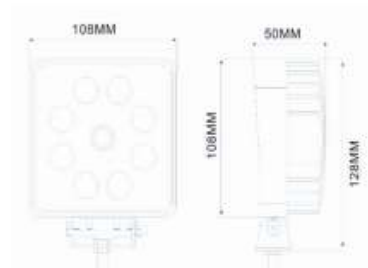



## IND8208I

1 pz.

Faro lavoro forma quadrata 9 led,  
**9/32v, 27W, 1850lumen**  
con interruttore e maniglia

Marchio Guidoni

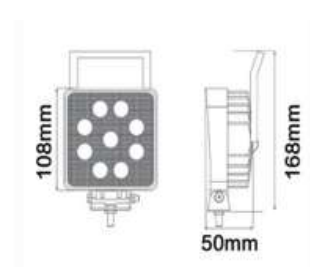

## IND8209

1 pz.

Faro da lavoro forma tonda 9 led **9-32V**  
**27W**  
diametro: 11 cm, 1755 lumen

Marchio Guidoni.

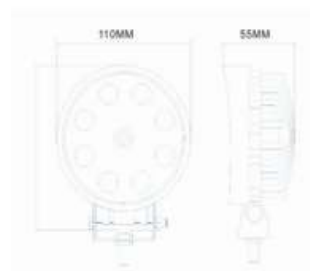

## IND8205-16

1 pz.

Faro da lavoro quadrato 16 led, **10/30V,**  
**32W**

Marchio Guidoni

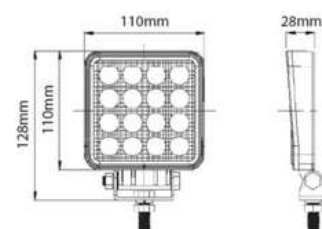

## IND8243

1 pz.

Faro da lavoro quadrato 16 led ,

**9/32V, 48W,**  
**3600 lumen.**

Marchio Guidoni

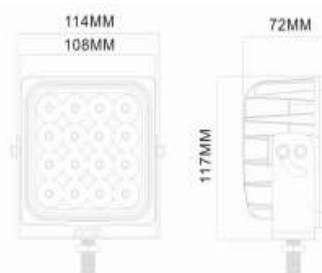

## IND8227

**IND8227SI** 1 pz.

CON  
interruttore

SENZA  
interruttore

dettagli articoli:

Faro da lavoro quadrato **12W**  
**1020 LUMEN**  
**12LED 9-32V IP68**  
**Misure: 76x95x25mm**

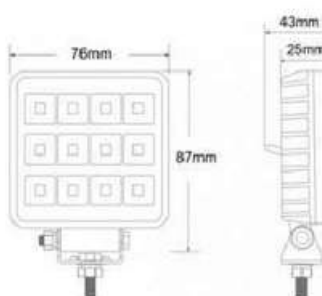

## IND8228

**IND8228SI** 1 pz.

CON interruttore SENZA

interruttore

dettagli articoli:

Faro da lavoro quadrato **16W**  
**1630LUMEN**  
**16LED 9-32V IP68**  
**Misure: 90x110x30mm**

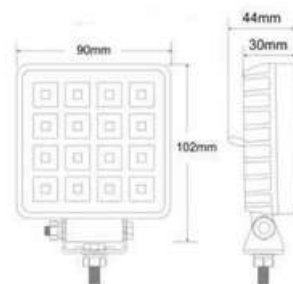

## 7- Fari da lavoro LED



### IND8210 1 pz.

Faro da lavoro quadrato 4 led  
**9-32V - 10W**  
misure: 6,6x6,6cm  
760 lumen

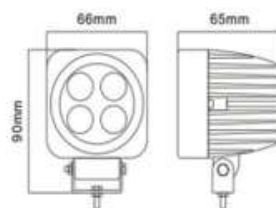

### IND8211 1 pz.

Faro da lavoro rettangolare 6 led  
**9-32V 18w**  
misure: 11x6cm  
1170 lumen

Marchio Guidoni.

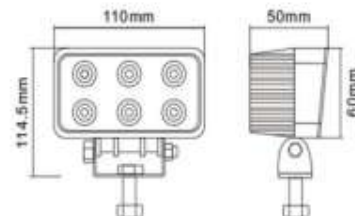

### IND8229 1 pz.

Faretto ovale 8 led **9-23V 24W**,  
1560 lumen

Marchio Guidoni.

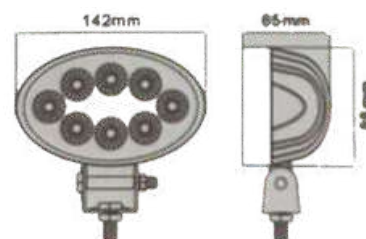

### IND8266 1 pz.

Faro tondo 9 LED base palo flessibile 9 LED  
**10-36V, 27W**

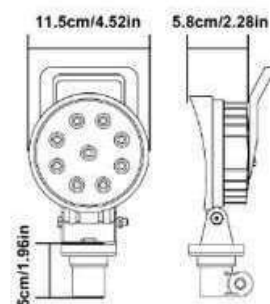

### IND8236 1 pz.

Faro lavoro LED quadrato  
base palo flessibile originale vignal.  
Con maniglia e interruttore.  
Doppia ottica, profondità ed espansione.

**9-32V**  
misure: 90x243x58mm  
1000 lumen

Marchio Guidoni.

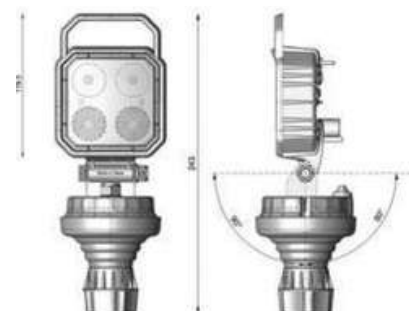

### IND8237 1 pz.

Faro lavoro LED tondo da incasso,  
originale vignal.  
Doppia ottica, profondità espansione.

Diametro **86mm**  
1000 lumen  
**9-32V**  
IP69k

Marchio Guidoni.





### IND8238

1 pz.

Faro lavoro LED tondo orientabile multidirezionale originale Vignal. Doppia ottica, profondità espansione.

Diametro **86mm**  
1000 lumen  
**9-32V**  
IP69k

Marchio Guidoni.

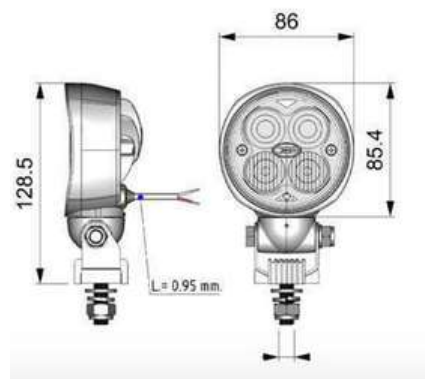

### IND8248

1 pz.

Base magnetica per faretto a led, diametro: **65mm**



### IND8241

1 pz.

Faro da lavoro rettangolare 6LED, **18W**, 1180 Lumen

**misure:** 45.2x160x63mm  
**10-30VDC** -6000K -IP68

Marchio Guidoni.



### IND8241HP

1 pz.

Faro da lavoro rettangolare 45LED, **45W**, 3600 Lumen

**misure:** 160X56X50mm  
**10-30VDC** -6000K -IP68

CE/ROhS,E-MARK

Marchio Guidoni.



### IND8214

1 pz.

Faro da lavoro quadrato 1 led cree **9-32V 10W**  
800 lumen  
**misure:** 70x70mm

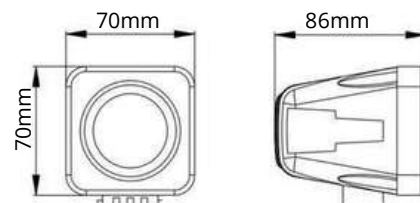

## 7- Fari da lavoro LED



**IND8215**

1 pz.

Faro da lavoro tondo 1LED  
diametro 8cm,  
cree **9-32V 10W**  
800 lumen

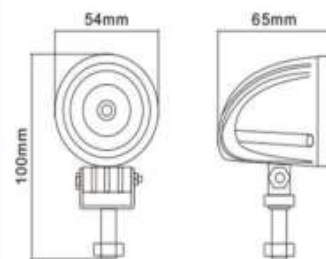

**IND8223**

**12LED** da **3W**  
(**36w** totali)  
**9-32V**

**IND8224**

1 pz.

**6LED** da **3W**  
(**12w** totali) **9-32V**

**misure: 165x80x68mm**

### BARRE LED

Marchio Guidoni.

**12/24V**

dettagli articoli

CODICE	FILA	WATT	LUMEN	MISURE	CF.
IND8225	DOPPIA (figura 1)	120W	720LM	56 cm	<b>1PZ.</b>
IND8226	DOPPIA (figura 1)	240W	1440LM	107 cm	<b>1PZ.</b>
IND8252	SINGOLA (figura 2)	60W	280LM	28 cm	<b>1PZ.</b>
IND8254	SINGOLA (figura 2)	120W	680LM	51 cm	<b>1PZ.</b>
IND8255	SINGOLA (figura 2)	180W	1400LM	76 cm	<b>1PZ.</b>
IND8258	SINGOLA (figura 2)	300W	1400LM	125 cm	<b>1PZ.</b>

### BARRE LED HIGH POWER

dettagli articoli:

Barre LED fila singola IP67 con cavo e connettore Deutsch DT

Ottica ad alta profondità

**12/24V**

CODICE	MISURE	LUMEN	WATT	CF.
IND8294	55.88CM	9500	120W	<b>1PZ.</b>
IND8295	83.8CM	1500	192W	<b>1PZ.</b>
IND8296	106.68CM	18600	240W	<b>1PZ.</b>

**IND8297**

1 pz.

Faro di potenza  
**12/24V 3X25W**  
7000 lumen  
Potenza effettiva 72W/ LED  
**misure: 25.8X7.5 X8.7cm**  
CHIP-ETI  
IP6K9K



### FARI LAVORO AMPIO RAGGIO

#### IND8262 1 pz.



Faro di lavoro a LED ampio raggio 240°  
54W LED EPISTAR  
**grado di impermeabilità:** IP67  
10-36VDC  
**temperatura colore:** 6000 K~6500 K  
**temperatura di funzionamento:**  
-40°C~60°C  
**lumen:** 4000 LM -  
fascio SPOT/FLOOD opzionale

**materiale:** in alluminio pressofuso staffa  
in acciaio inossidabile

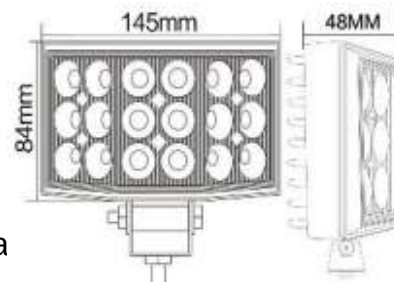

#### IND8259 1 pz.

Faro da lavoro a LED quadrato ampio raggio 360°

**12/24V 40W**  
9 LED frontali  
24 LED laterali  
**misure:** 10.5X10.5X53

applicazioni:  
Truck, agricoltura, movimento terra, macchine operatrici

### FARI DA INCASSO

#### IND8250 1 pz.

Faro lavoro LED EPISTAR da incasso tondo  
diametro 12cm  
- **10-36V**  
- 6 LED 18W  
- 6000K 1350 lumen

#### IND8246 1 pz.

Faro lavoro LED EPISTAR da incasso  
rettangolare  
**10-36V**  
**misure:** 150X84X40mm  
- 6 LED 18W  
- 6000K 1350 lumen

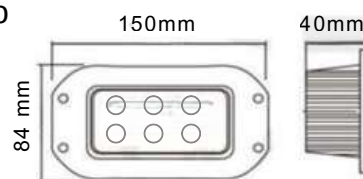

## 7- Fanali e fari LED

### IND8247

1 pz. 



Faro lavoro LED CREE  
con cornice rettangolare  
**10-36V**  
**misure:**180X100X57mm  
13LED - 39W  
- 2925 lumen

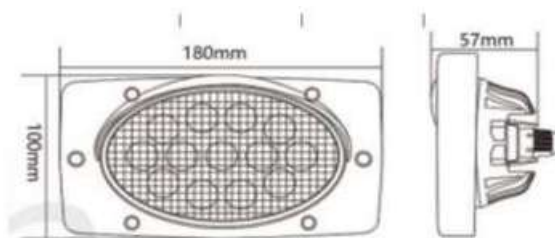

### IND8244

1 pz. 

Proiettore LED tondo da incasso, 4 LED  
con anello luce diurna DRL, **12/24V**  
Marchio Guidoni



### PROIETTORI E FARI DA LAVORO ANTERIORI

#### IND8233

1 pz. 



Coppia di proiettori LED DX+SX **12/24V**

**misure:** 224X148X108mm

**funzioni:**

- anabbagliante 30W 3000LUMEN
- abbagliante 90W 7200LUMEN
- Posizione/drl 12W 1200 LUMEN
- Indicatore di direzione ANT+POST 6W 600 LUMEN IP67

**certificazioni:**

CISPR25  
CLASSE 4

#### IND8235-1

1 pz. 



Proiettore LED 12/24V 99W 8000 LUMEN

**misure:** 167.6 x 107.5 x 80mm IP67  
completo di staffe di fissaggio

**funzioni:**

- anabbagliante 30W
- abbagliante 90W

**applicazioni:**

NEW HOLLAND  
MASSEY FERGUSON  
JOHN DEERE

#### IND8260

1 pz. 



Faro di lavoro a LED con  
indicatore di direzione  
**75W 12-24V EPISTAR**  
**misure:** 109x53x136mm

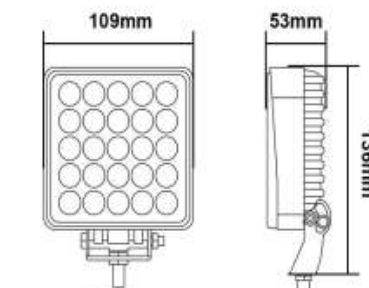

#### IND8261

1 pz. 



Faro di lavoro a LED ovale  
con indicatore di direzione  
36W CREE 10-110 VDC  
**misure:** 90x50x140mm

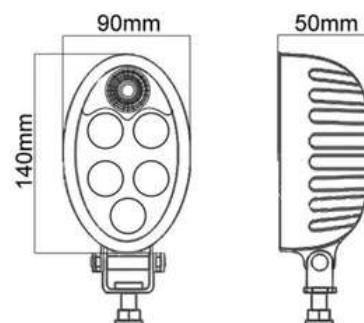

### FARI DA LAVORO LED SPOT BLU E LINEA ROSSA PER CARRELLI ELEVATORI



**IND8206-80V** 1 pz.

Faro da lavoro quadrato 9 LED,  
10/110V- 27W

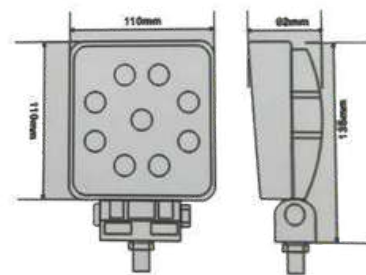

**IND8230** 1 pz.

Faro da lavoro quadrato LED 10-110V  
-40W per carrelli elevatori,  
3200 lumen

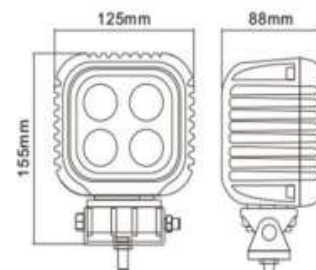

**IND8221** 1 pz.

Faro da lavoro led e spot **blu**  
operanti a 10-110V per carrelli  
elevatori.

Marchio Guidoni.

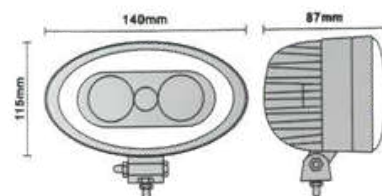

**IND8222** 1 pz.

Faro da lavoro led e spot **blu**  
modello economico, operativo a  
10-110V , per carrelli elevatori.

Marchio Guidoni.

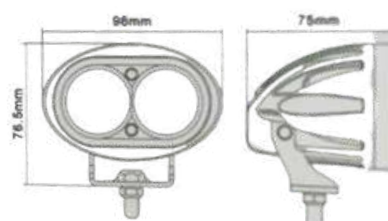

**IND8220** 1 pz.

Faro da lavoro LED 10-110V  
linea **rossa** per carrelli elevatori.

Marchio Guidoni.



## 7- Lampeggianti e multiflash LED



**IND8220T**

1 pz.

Faro LED linea **rossa**  
forma rettangolare per carrelli  
elevatori.

**10-110V -30W,**  
working life 30.000 ore

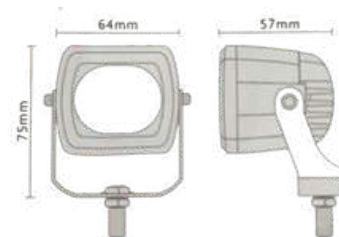

**IND8220Q**

1 pz.

Faro LED linea **rossa**  
forma quadrata per carrelli elevatori.

**10-110V , 30W**  
working life 30.000 ore

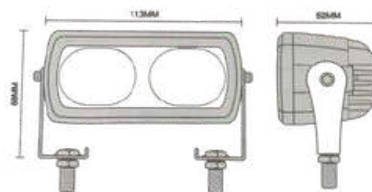

### LAMPEGGIANTI MULTIFLASH ENTRY LEVEL

18 TIPI DI LAMPEGGIO SINCRONIZZABILI

#### LAMPEGGIANTI 3 LED

CODICE	MISURE	VOLT	N.LED	COLORE	FISSAGGIO	CF.
IND8332R	9,3X82,5X30mm	12/24V	3	<b>ROSSO</b>	a vite con adesivo	1PZ.
IND8332BI	9,3X82,5X30mm	12/24V	3	<b>BIANCO</b>	a vite con adesivo	1PZ.
IND8332	9,3X82,5X30mm	12/24V	3	<b>ARANCIONE</b>	a vite con adesivo	1PZ.
IND8332BL	9,3X82,5X30mm	12/24V	3	<b>BLU</b>	a vite con adesivo	1PZ.

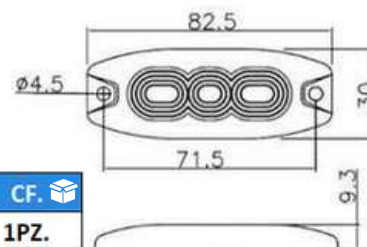

\*IND 8332BL FILO DEDICATO PER LUCE DI CROCIERA



#### LAMPEGGIANTI 4 LED

CODICE	MISURE	VOLT	N° LED	COLORE	FISSAGGIO	CF.
IND8334R	8,3X98,5X30mm	12/24V	4	<b>ROSSO</b>	a vite con adesivo	1PZ.
IND8334BI	8,3X98,5X30mm	12/24V	4	<b>BIANCO</b>	a vite con adesivo	1PZ.
IND8334	8,3X98,5X30mm	12/24V	4	<b>ARANCIONE</b>	a vite con adesivo	1PZ.
IND8334BL	8,3X98,5X30mm	12/24V	4	<b>BLU</b>	a vite con adesivo	1PZ.
IND8334BIF	8,3X98,5X30mm	12/24V	4	<b>BIANCO</b> fisso	a vite con adesivo	1PZ.

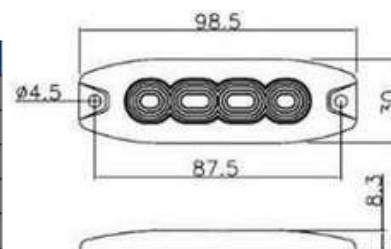

\*IND 8334BL FILO DEDICATO PER LUCE DI CROCIERA



## 7- Lampeggianti e multiflash LED

### LAMPEGGIANTI 6 LED

CODICE	MISURE	VOLT	N° LED	COLORE	FISSAGGIO	CF. 
IND8335R	7,3X130,5X30mm	12/24V	6	ROSSO	a vite con adesivo	1PZ.
IND8335BI	7,3X130,5X30mm	12/24V	6	BIANCO	a vite con adesivo	1PZ.
IND8335	7,3X130,5X30mm	12/24V	6	ARANCIONE	a vite con adesivo	1PZ.
IND8335BL	7,3X130,5X30mm	12/24V	6	BLU	a vite con adesivo	1PZ.
IND8335BIF	7,3X130,5X30mm	12/24V	6	BIANCO fisso	a vite con adesivo	1PZ.

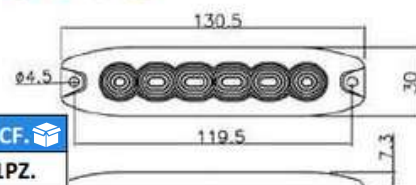

\*IND 8335BL FILO DEDICATO PER LUCE DI CROCIERA



### LAMPEGGIANTI 24 LED

CODICE	MISURE	VOLT	N.LED	COLORE	FISSAGGIO	CF. 
IND8370BL	130X96mm	12/24V	24	BLU	con adesivo 3M	1PZ.
IND8370	130X96mm	12/24V	24	ARANCIONE	con adesivo 3M	1PZ.



### MULTIFLASH TOP QUALITY

**IND8910B**

**COLORE BLU**

dettagli articoli:

Multiflash 3 LED 12/24

con luce di crociera

**misure:** 82X30X11mm

19 tipi di lampeggio con cornice fissaggio a vite

IP69K

-omologazione ECE, R10, R65 - SAES95

**IND8910A**

**COLORE ARANCIONE**

1 pz. 

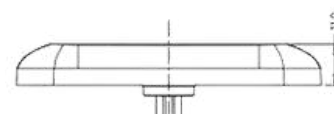
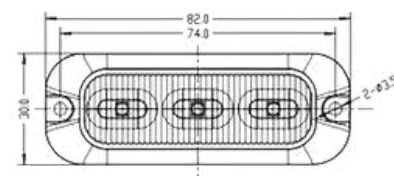

**IND8911B**

**COLORE BLU**

dettagli articoli:

Multiflash 4 LED 12/24V

19 tipi di lampeggio con cornice fissaggio a vite

**misure:** 98x30x11 mm

-omologazione ECE, R10, R65 - SAES95

**IND8911A**

**COLORE ARANCIONE**

1 pz. 

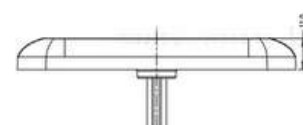
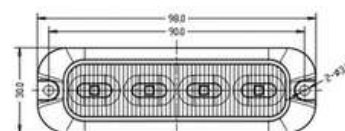

## 7- Lampeggianti e multiflash LED

**IND8912B**

**COLORE BLU**

**IND8912A**

**COLORE ARANCIO**

1 pz. 



Multiflash 6 LED 12/24  
con luce di crociera

**misure:** 130X30X11

19 tipi di lampeggio con cornice fissaggio a vite

IP69K -

-omologazione **ECE, R10, R65 - SAES95**

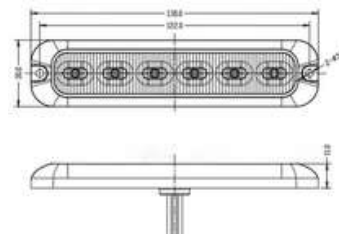

**IND8914**

1 pz. 

Portatarga con 4 multiflash IND8912B

**misure:** 537X174.5X41mm

IP69K

CE,UKCA,ECE R10,R65 CLASS 2, SAEJ595 CLASS1



**IND8915B**

1 pz. 

Multiflash 12 LED da 3W 12/24 **BLU** con luce di crociera

**misure:**100X36X11.9

12 tipi di lampeggio

base in alluminio e lenti in policarbonato

IP69K - ECE R10 R65 - SAEJ595



### MULTIFLASH FLESSIBILE IN SILICONE

**IND8373B**

**COLORE BLU**

**IND8373A**

**COLORE ARANCIO**

1 pz. 



dettagli articoli:

Un' efficace resistenza a gli urti alla corrosione . Può piegarsi all'indietro fino a 30°. Migliore design anti ingiallimento e antiossidante delle lenti rispetto a quelle tradizionali. Montaggio con adesivo 3M o montaggio a vite.

**Misure:**112.8x26.2x10.9

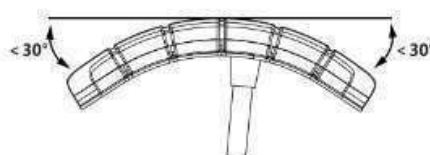
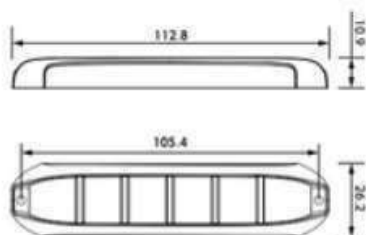

Max 30° angle from center



No Twisting



No Pulling



## 7- Lampeggianti e multiflash LED



**IND8360B**  
**COLORE BLU**

**IND8360A** 1 pz.   
**COLORE ARANCIO**

dettagli articoli:

**4 LED**  
**misure:** 130X40X11mm  
IP67/IP69K  
14 tipi di lampeggio  
pieghevole fino a 30°  
fissaggio a vite o con adesivo 3M  
ECE R10 ECE R65, SEJ595

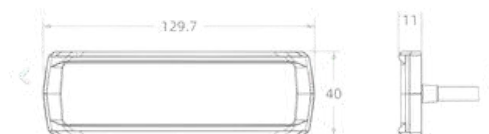

**IND8361B**  
**COLORE BLU**

**IND8361A** 1 pz.   
**COLORE ARANCIO**

dettagli articoli:

**6 LED**  
**misure:** 130X25X11mm  
IP67/IP69K  
14 tipi di lampeggio  
pieghevole fino a 30°  
fissaggio a vite o con adesivo 3M  
ECE R10 ECE R65, SEJ595

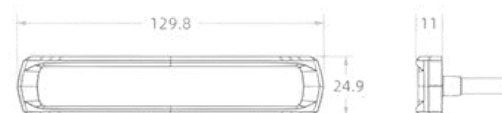

### MULTIFLASH DA INTERNO PER PARABREZZA



**IND8368**  
**COLORE BLU**

**IND8367** 1 pz.   
**COLORE ARANCIO**

dettagli articoli:

- due moduli **30W** alta luminosità  
- **12V** 22 lampeggi programmabili  
adatto per parabrezza anteriore e posteriore  
fissaggio a ventosa  
**misure:** 247X141X83

**IND8367-1** 1 pz.

Multiflash da interno per parabrezza  
12V **arancio** 1 modulo

6X4W con cavo di 3mt con spina accendisigari  
19 lampeggi  
fissaggio a ventosa  
153.7X37.6X103.5  
ECE R10, CE, ECE R65 CLASSE 2,  
SAJE 595 CLASSE 1

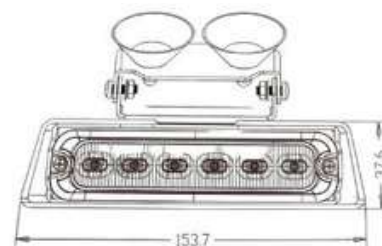

## 7- Lampeggianti e multiflash LED



**IND8374B**  
**COLORE BLU**

**IND8374A**  
**COLORE ARANCIO**

1 pz.

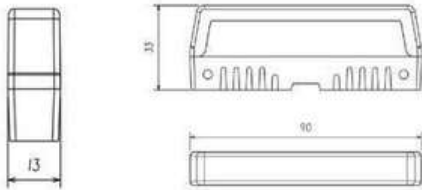

dettagli articoli:

- tensione: **10-30V DC**
- 8LED ampia visibilità
- potenza **12X3W 18X3W**
- IP IP67
- ECE R65 R10
- diffusione luce 180° wide
- montaggio a superficie, montaggio su staffa
- misure **90X33X13mm**
- omologazione **R65 R10**
- adatto per griglie frontali
- 20 tipi di lampeggio cruise (luce di crociera) + regolazione intensità (dimmer)



**IND8369** 1 pz.

Spot multi flash led dc **10/30V** - colore **BLU**  
con cornice e fissaggio a vite

**IND8364**  
**COLORE BLU**

**IND8364A**  
**COLORE ARANCIO**

1 pz.



Spot multiflash LED  
12/24V  
con cornice fissaggio a vite  
12 tipi di lampeggio  
diametro: 36MM - altezza: 31mm  
Omologazioni: NR65, XA1, R10

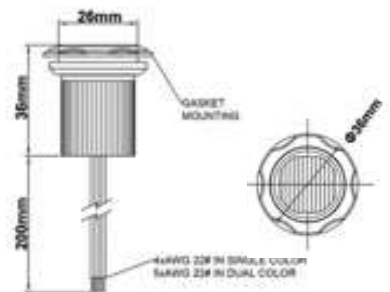

**IND8363B**  
**COLORE BLU**

**IND8363A**  
**COLORE ARANCIO**

1 pz.

multiflash 12/24V - 4X3W LED  
fissaggio a vite  
12 tipi di lampeggio  
misure: 74X55X142MM  
omologazione: R65, R10

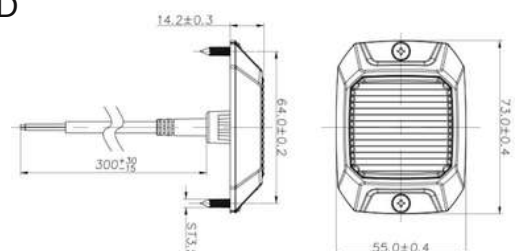

### MULTIFLASH PIÙ FARO LAVORO



**IND8372B**  
**COLORE BLU**

**IND8372A**  
**COLORE ARANCIO**

1 pz.

dettagli articoli:

Multiflash più faro lavoro  
un'efficace resistenza agli urti e alla corrosione.  
Inclinazione di 25°  
9 tipi di lampeggio senza lunetta  
**misure:** 45X45X19mm

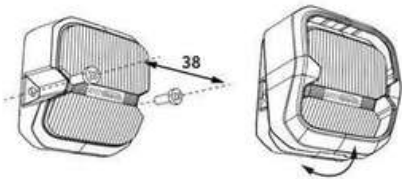

**IND8366** 1 pz.

Multiflash **BLU** 12/24 V +faro lavoro **BIANCO**  
**misure:** 180X105X31

La luce può coprire 180°

IP 67

temperatura di esercizio -40° -> + 70°

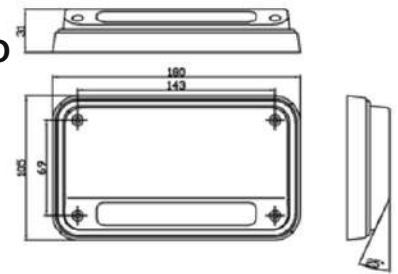

**IND8916B** 1 pz.

Plafoniera più multiflash 12/24V **blu** con luce crociera

**misure:** 179.7x60.9x28mm

3000 lumen - IP69K

faro lavoro 6 LED da 4W

omologazioni:

**SAE, ECE, R65-R10-R148**



### STRISCIA LED FLESSIBILE

**IND8375-34** 1 pz.

Striscia LED flessibile **12/24V** colore **arancione**  
con movimento luce dinamica.

**misure :** 34cm

**applicazioni:**

plantonì di stazionamento di veicoli industriali, gru,  
macchine operatrici.



## FARI LED LAMPEGGIANTI

**IND8371A**   **IND8371R**   **IND8371B**   1 pz. 

**COLORE**   **COLORE**   **COLORE**  
**ARANCIO**   **ROSSO**   **BLU**



dettagli articoli:

Faro LED EPISTAR  
lampeggiante quadrato

**9-32V, 5 LED, 15W**

**misure: 99x72x42mm**

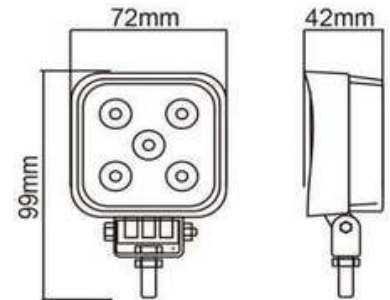

## LAMPEGGIANTI PER CARRELLI ELEVATORI



**IND8346**   1 pz. 

Lampeggiante LED **arancione** a base  
tonda per applicazioni industriali

**12-110V**  
misure:97x58x130mm

Marchio Guidoni.

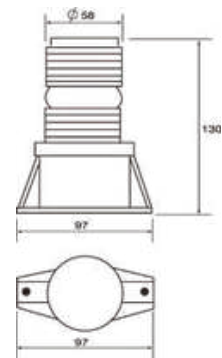

**IND8347**   1 pz. 

Protezione di sicurezza in acciaio inox  
a base tonda per lampeggianti LED e xenon per IND8346

Marchio Guidoni.



**IND8305L**   1 pz. 

Lampeggiante LED **12-110V**,  
**arancione**, base piana  
potenza **4W**, 117 lumen  
misure:130x93x85mm

Marchio Guidoni.

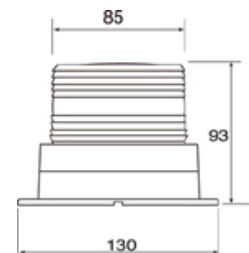

**IND8306**   1 pz. 

Protezione di sicurezza in acciaio inox a base tonda per  
lampeggianti LED e xenon per IND8305L

Marchio Guidoni.

## 7- Lampeggianti e multiflash LED



**IND8348**

1 pz.

Lampeggiante LED con avvisatore acustico retromarcia integrato colore **arancione**, buzzer integrato, **12-110V**, 5 tipi di lampeggio omologato **R65-R10**  
**misure:** altezza 89mm diametro 130mm

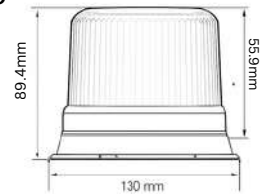

omologazioni:

R65-R10



**IND8349**

1 pz.

Lampeggiante LED base palo colore **arancione** **12/110V** per carrelli elevatori 5 tipi di lampeggio  
**misure:** altezza 153mm diametro 101mm

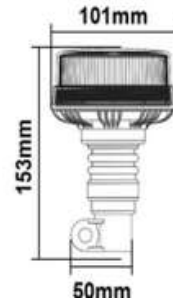

omologazioni:

ECE, R65, R10

### LAMPEGGIANTI LED OMOLOGATI



**IND8315**

1 pz.

Lampeggiante venus LED base piana **12/24V**, colore **arancione**  
**misure:**146x127mm

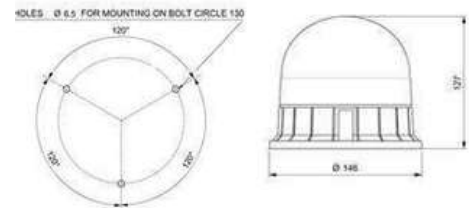

**IND8316**

1 pz.

Lampeggiante venus LED base palo **12/24V**, colore **arancione**  
**misure:**128x172mm

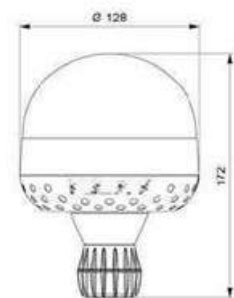

**IND8317**

1 pz.

Lampeggiante venus LED magnetico **12/24V**, colore **arancione**  
**misure:**146x135mm

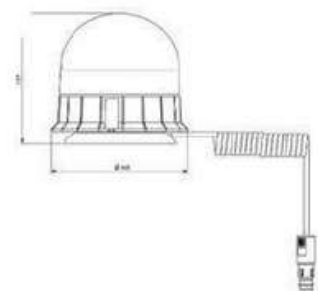

Marchio Guidoni.



## 7- Lampeggianti e multiframe LED



**IND8336**

**COLORE BLU**  
con luce di crociera

**IND8337**

**COLORE ARANCIO**

1 pz.

dettagli articoli:

Lampeggiante LED base piana **10-30V**

22 Modelli di flash selettivi integrati, inclusi 5 modelli di rotazione simulati il nuovo design "lente reflex" garantisce la massima intensità e luminosità del LED

Adatto a tutti i tipi di veicoli per la sicurezza stradale.

**omologazioni:**

SAE, ECE R65, R10

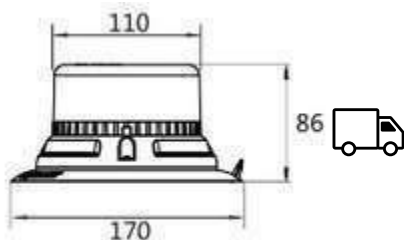

**IND8338**

1 pz.

Lampeggiante LED magnetico colore **arancio** **12-24V** con 6 funzioni di lampeggiamento.

Marchio Guidoni.

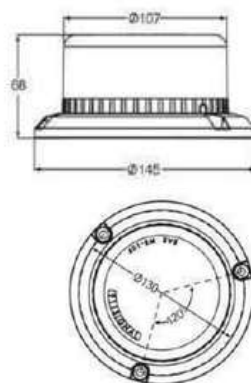

**IND8340**

1 pz.

Lampeggiante LED base palo colore **arancio** **10-30V**  
**omologazioni:**

SAE, ECE R65 e R10

Marchio Guidoni.

D. 10,5 CM

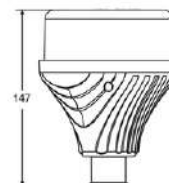

**IND8321**

**COLORE BLU**  
con luce di crociera

**IND8320**

**COLORE ARANCIO**

1 pz.

dettagli articoli:

Lampeggianti LED base piana con luce di crociera a **12-24V** IP65, Classe 1 potenza LED **54W**

**omologazioni:** ECE, R65

Marchio Guidoni.

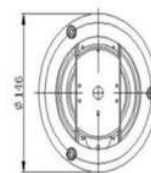
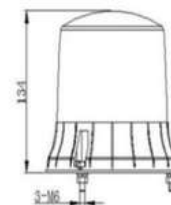

## 7- Lampeggianti e multiflash LED



**IND8322**

1 pz. 

Lampeggiante LED magnetico  
colore **arancio** con accendisigari e  
luce di crociera  
**12-24V** IP65, Classe 1 potenza LED  
**54W**  
misure:150x180mm

omologazioni:

ECE, R65

Marchio Guidoni.



**IND8341M**

**COLORE BLU**

**IND8342M**

**COLORE ARANCIO**

1 pz. 

dettagli articoli:

Lampeggianti LED magnetici  
a **10-30V 18x3W** 240km/h  
misure: 110X50mm  
10 funzioni di lampeggiamento  
con spinotto accendisigari con cavo di **2.5mt**

omologazioni:

R65, TA2, TB2, CEC, R10



**IND8341P**

1 pz. 

Lampeggiante LED base palo  
colore **blu**  
a **10-30V 18x3W** 240km/h  
misure:110X50mm  
10 funzioni di lampeggiamento  
con spinotto accendisigari con cavo di **2.5mt**

omologazioni:

R65, TA2, TB2, CEC, R10



**IND8318**

1 pz. 

Lampeggiante LED magnetico  
colore **arancio**  
**12/24V ricaricabile**  
con spinotto accendisigari  
misure: altezza 98mm diametro 123mm

omologazioni:

R65-R10



## 7- Lampeggianti e multiflash LED



**IND8344**

1 pz.

Lampeggiante LED Taurus base piana  
colore **blu**  
**10/30V** in policarbonato  
**misure:** altezza 158mm diametro 146mm

omologazioni:

R10

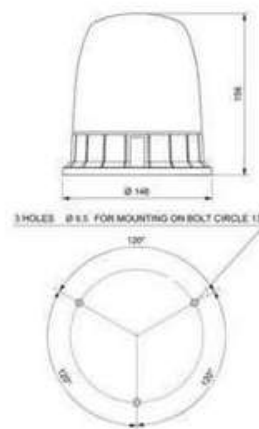

### SUPPORTI PER LAMPEGGIANTI BASE PALO



**IND8307**

1 pz.

Supporto per lampeggianti base palo da avvitare  
Marchio Guidoni.



**IND8308**

1 pz.

Supporto per lampeggianti base palo da saldare  
Marchio Guidoni.



**IND8310**

1 pz.

Supporto per lampeggianti base palo con staffa centrale  
Marchio Guidoni.



**IND8311**

1 pz.

Supporto per lampeggianti base palo con staffa laterale  
Marchio Guidoni.

### SPINOTTI PER LAMPEGGIANTI



**IND8309**

1 pz.

Spinotto per lampeggianti  
Marchio Guidoni.



## 7- Barre LED lampeggianti

### MINI BARRE LED



12/24V

CODICE	COLORE	MISURE	FISSAGGIO	FUNZIONI DI LAMPEGGIO	CF.
IND8357	ARANCIO	248X172X37mm	MAGNETICO	22 FUNZIONI	1PZ.
IND8356	ARANCIO	248X172X37mm	A VITE	22 FUNZIONI	1PZ.
IND8355	BLU	248X172X37mm	A VITE	22 FUNZIONI	1PZ.

### BARRE LAMPEGGIANTE A LED

12/24V



#### caratteristiche

Con luce di crociera  
cavo 150cm  
17 tipi di lampeggio IP67

#### certificazioni

SAE J845 CAT.13 ECE R65  
CLASSE2 ECE R10

CODICE	COLORE	MISURE	CF.
IND8376A	ARANCIO	603X281X48mm	1PZ.
IND8380A	ARANCIO	907X281X48mm	1PZ.
IND8380B	BLU	907X281X48mm	1PZ.
IND8381A	ARANCIO	1211X281X48mm	1PZ.
IND8381B	BLU	1211X281X48mm	1PZ.
IND8382A	ARANCIO	1515X281X48mm	1PZ.
IND8382B	BLU	1515X281X48mm	1PZ.
IND8383A	ARANCIO	1819X281X48mm	1PZ.
IND8383B	BLU	1819X281X48mm	1PZ.

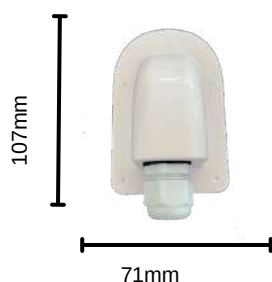
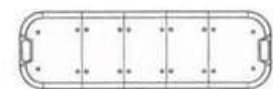
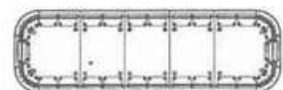

#### IND8377

1 pz.

Accessorio passaparete

1VIA stagno IP67

**misure:**44x71x107mm (HxWxP)

Adatto per montaggio su tutti i tipi di barre e lampeggianti LED

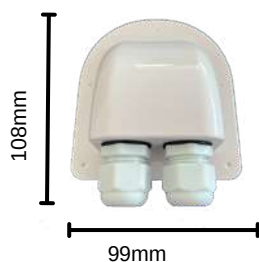

#### IND8378

1 pz.

Accessorio passaparete

2VIE stagno IP67

**misure:**44x99x108mm (HxWxP)

Adatto per montaggio su tutti i tipi di barre e lampeggianti LED



### TASTIERINI E CONTROLLER



**IND8379-1** 1 pz.

**12/24V**

Controller per barre a led **12/24V**  
4 funzioni, interruttori o pulsanti, adesivo 3M

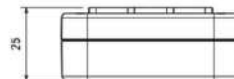
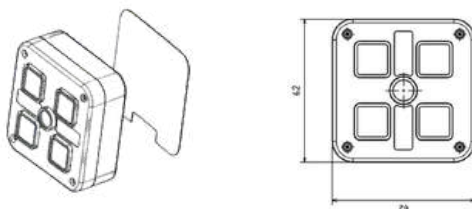

**IND8379-1B** 1 pz.

Supporto per **IND8379-1**  
per fissaggio a vite o con adesivo 3M



**IND8379-1B** 1 pz.

Supporto per **IND8379-1**  
per fissaggio a ventosa



**Y6864** 1 pz.

Tastierino di controllo 6 tasti  
**12/24V**

massima potenza: **12V 1200W 24V 600W**

misure: 92x66x15.9MM

Il kit comprende:

80 simboli adesivi

accessori per l'installazione e fusibile di  
potenza ripristinabile



Circuit 1	Circuit 2	Circuit 3
5A	10A	10A
Circuit 4	Circuit 5	Circuit 6
20A	20A	30A

**Y7116** 1 pz.

Tastierino di controllo 8 tasti RGB

**12/24V**

massima potenza: **12V - 1440W - 24V 720W**

massimo amperaggio: 60A

temperatura di utilizzo: -40° +85°

misure: 135x66x23mm

Il kit comprende:

140 simboli adesivi

accessori per l'installazione e fusibile di potenza  
ripristinabile.



## PLAFONIERE LED



**IND8559**

1 pz.

Mini plafoniera 3 LED SMD **12-24V**  
**misure:** 84X24X10mm

Marchio Guidoni.



**IND8578**

SENZA  
INTERRUTTORE

**IND8579**

CON INTERRUTTORE  
TOUCH

1 pz.

[dettagli articoli](#)

Plafoniera LED tonda **12/24V**

Diametro 130mm

1080 LUMEN IP67 adatta per isothermici -40°+65°

ECE R10



**IND8552**

1 pz.

Plafoniera LED tonda **12/24V**

Diametro 160mm

IP67 1200, LUMEN, R10

da incasso per furgoni isothermici

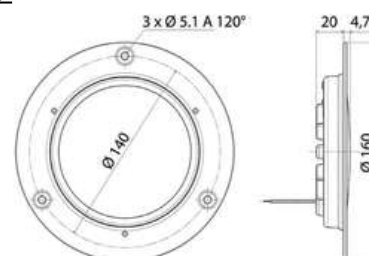

**IND8575-220**

SENZA  
INTERRUTTORE

**IND8575-220P**

CON INTERRUTTORE  
TOUCH

1 pz.

[dettagli articoli](#)

Plafoniera LED forma rettangolare **12/24V**

**misure:** 220X75X11mm

860 LUMEN

4500K IP67

adatta per isothermici -40°+65°

ECE R10

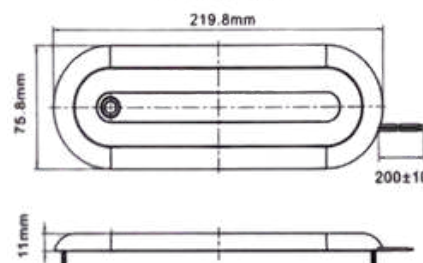

## 7- Plafoniere LED



**IND8585** 1 pz. 

Plafoniere LED quadrata,  
**misure:** 124x124mm,

adatta per isothermici,  
**12/24V** 500 lumen,  
 IP69K R-10

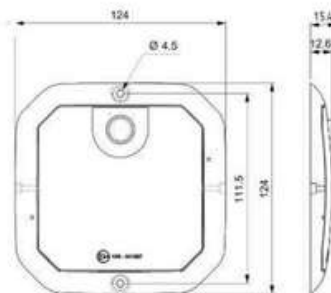

dettaglio articoli

Plafoniere LED rettangolare

adatta per isothermici -40°+65° **IP67 4500K**

ECE R10

**12/24V**



CODICE	INTERRUTTORE	LUMEN	MISURE	CF. 
IND8574-175	senza PIR	280LM	175X54X11mm	<b>1PZ.</b>
IND8574-300	senza PIR	680LM	300X54X11mm	<b>1PZ.</b>
IND8574-500	senza PIR	1400LM	500X54X11mm	<b>1PZ.</b>
IND8574-500P	con PIR	1400LM	500X54X11mm	<b>1PZ.</b>

## PLAFONIERE PER ILLUMINAZIONE INTERNA THIN LINEAR

dettaglio articoli

Plafoniere thin linear componibile e regolabile.  
 Luce bianca, fredda. **12V o 24V**

Marchio Guidoni.



CODICE	MISURE	VOLT	N°LED	CF. 
IND8538	300x34mm	12V	42	<b>1PZ.</b>
IND8539	500x34mm	12V	56	<b>1PZ.</b>
IND8540	1000x34mm	12V	112	<b>1PZ.</b>
IND8546	300x34mm	24V	42	<b>1PZ.</b>
IND8547	500x34mm	24V	56	<b>1PZ.</b>
IND8548	1000x34mm	24V	112	<b>1PZ.</b>

**IND8541** 1 pz. 

Connettore di uscita per plafoniere.

Marchio Guidoni.

**IND8542** 1 pz. 

Interruttore per plafoniere thin linear.

Marchio Guidoni.



## 7- Plafoniere LED



**IND8543**

1 pz.

Giunzione per plafoniere thin linear.  
Marchio Guidoni.



**IND8544**

1 pz.

Sensore PIR regolabile per plafoniere thin linear.  
Marchio Guidoni.



**IND8545**

1 pz.

Interruttore generale per plafoniere thin linear.  
Marchio Guidoni.

### PLAFONIERE LED CON INTERRUTTORE

dettagli articoli

Plafoniere LED con interruttore, in alluminio con lente in policarbonato, colore bianco freddo  
**12/24V**

Marchio Guidoni.



CODICE	LED	LUMEN	MISURE	CF.
IND8534	18 LED	380	266X28X13,5mm	<b>1PZ.</b>
IND8536	81 LED	1620	970X28X13,5mm	<b>1PZ.</b>
IND8537	45 LED	900	570X28X13,5mm	<b>1PZ.</b>

### LEGGI MAPPA FLESSIBILI



**IND8553**

1 pz.

Leggi mappa flessibile LED, 192 lumen, **12V**, 325mm  
Marchio Guidoni.



## PLAFONIERE PER ILLUMINAZIONE ESTERNA MONTAGGIO ANGOLARE

SCENE  
LIGHT 45°

**IND8590**

1 pz. 



Plafoniera LED montaggio angolare **12/24V**

-**misure:** 230x41x29mm

-IP67

-6 LED da 3W

applicazione ambulanze vigili del fuoco

**schema tecnico figura 9**



dettagli articoli



CODICE	SCHEMA TECNICO	WATT	LUMEN	COLORE	MISURE	CF. 
IND8591B	Figura 1	9W	750LM	BIANCO	129X68X65mm	<b>1PZ.</b>
IND8591N	Figura 1	9W	750LM	<b>NERO</b>	129X68X65mm	<b>1PZ.</b>
IND8592B	Figura 2	18W	1450LM	BIANCO	229X68X65mm	<b>1PZ.</b>
IND8592N	Figura 2	18W	1450LM	<b>NERO</b>	229X68X65mm	<b>1PZ.</b>
IND8593B	Figura 3	27W	2250LM	BIANCO	329X68X65mm	<b>1PZ.</b>
IND8593N	Figura 3	27W	2250LM	<b>NERO</b>	329X68X65mm	<b>1PZ.</b>
IND8594B	Figura 4	36W	3200LM	BIANCO	451X68X50.5mm	<b>1PZ.</b>
IND8594N	Figura 4	36W	3200LM	<b>NERO</b>	451X68X50.5mm	<b>1PZ.</b>
IND8595B	Figura 5	54W	4300LM	BIANCO	569X68X65mm	<b>1PZ.</b>
IND8595N	Figura 5	54W	4300LM	<b>NERO</b>	569X68X65mm	<b>1PZ.</b>



dettagli articoli

CODICE	SCHEMA TECNICO	WATT	LUMEN	COLORE	MISURE	CF. 
IND8596B	Figura 6	18W	1450LM	BIANCO	230X58X47mm	<b>1PZ.</b>
IND8596N	Figura 6	18W	1450LM	<b>NERO</b>	390X58X47mm	<b>1PZ.</b>
IND8597B	Figura 7	30W	2500LM	BIANCO	311X58X47mm	<b>1PZ.</b>
IND8597N	Figura 7	30W	2500LM	<b>NERO</b>	311X58X47mm	<b>1PZ.</b>
IND8598B	Figura 8	42W	3500LM	BIANCO	390X58X47mm	<b>1PZ.</b>
IND8598N	Figura 8	42W	3500LM	<b>NERO</b>	390X58X47mm	<b>1PZ.</b>

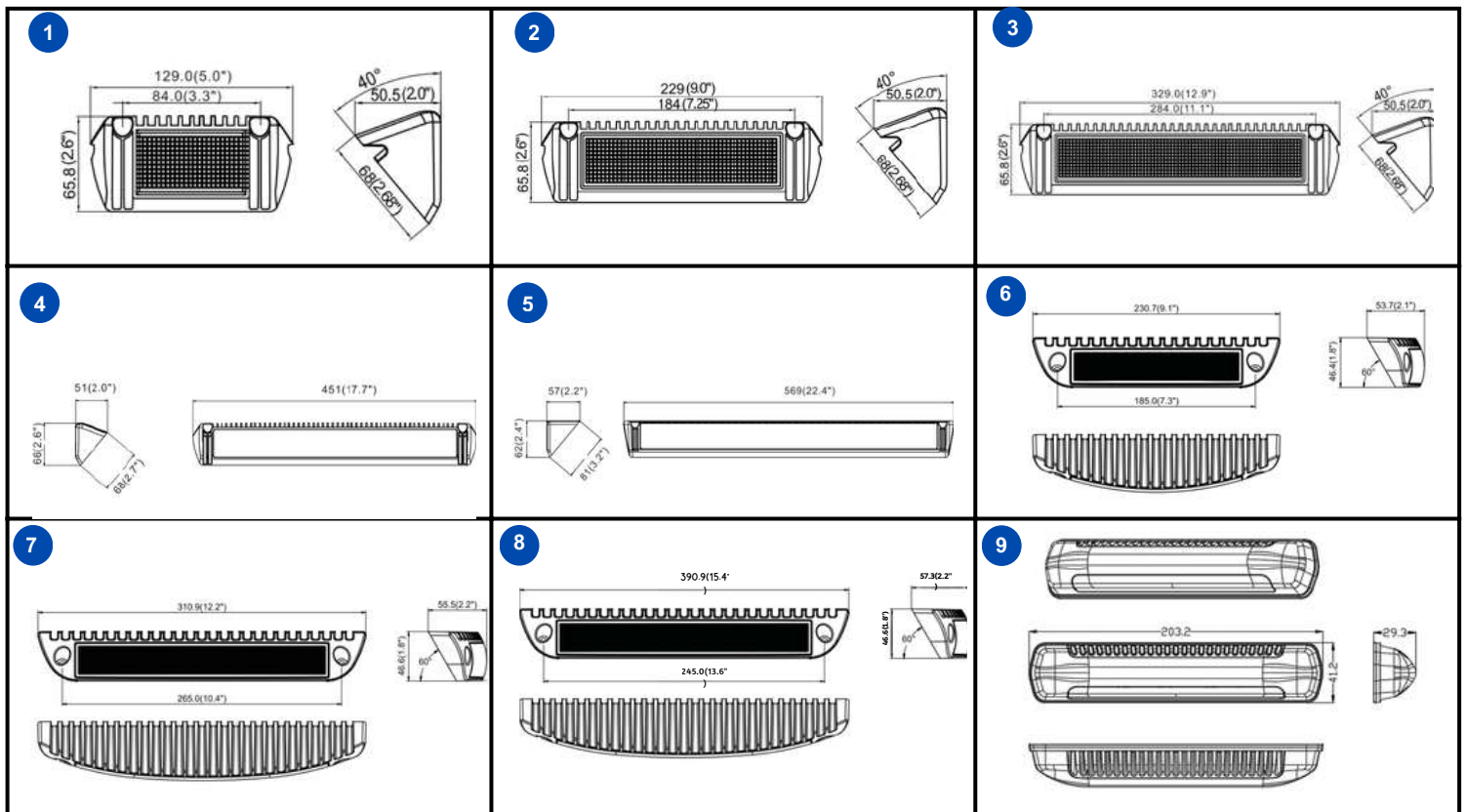

### IND8251

1 pz.

Plafoniera LED colore nero  
18W, 1450 LUMEN  
misure: 132.9X43.9mm

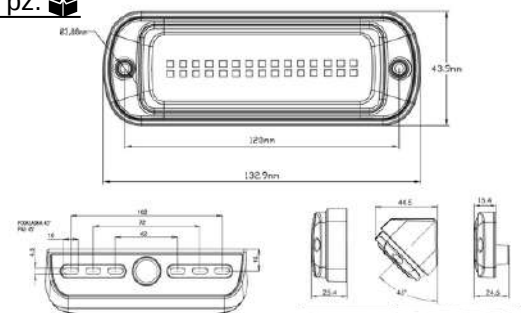

### IND8589

1 pz.

Plafoniera LED colore bianco 12/24V 40W  
2500LUMEN 6000K fissaggio angolare  
misure: 251X38X53  
OMOLOGAZIONI R10



## 7- Strisce LED

### SERIE STRISCE A LED 10MM

[dettagli articoli](#)

Striscia LED continua adesiva, vari colori, 10mm, 528 LED/mt, 15W/mt 1450 lumen/mt - IP66 tagliabile ogni 22.7mm, **Adesivo 3M**

CODICE	VOLT	COLORE	CF. 
OSR9992-1	12V	BIANCO	5MT
OSR9992-1BL	12V	BLU	5MT
OSR9992-1-24	24V	BIANCO	5MT



### Connettori per strisce luce continua LED

**OSR9993-1**      **OSR9993-2**      **OSR9993-3**      5pz. 

Connettore di giunzione

Connettore di alimentazione  
misura: 15cm

Connettore di giunzione  
misura: 15cm



### SERIE STRISCE A LED 5 MM

[dettagli articoli](#)

Striscia LED continua adesiva, 5mm **400LED/mt, 14W/mt**, tagliabile ogni 22,7mm **adesivo 3M** - IP66.

La particolarità di questa luce LED continua è l'altezza della striscia che rende possibile la sua applicazione negli spazi più ristretti.

CODICE	VOLT	COLORE	CF. 
OSR9992BL	12V	BLU	5MT
OSR9992R	12V	ROSSO	5MT
OSR9992V	12V	VERDE	5MT
OSR9992	12V	BIANCO	5MT

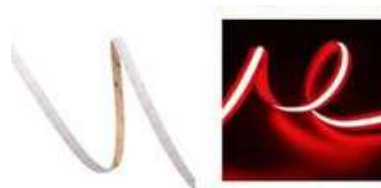

### STRISCE LED LUCE CONTINUA

Materiale silconico

**480LED/MT**

**6000K**

**Adesivo 3M - IP67** luce frontale

**12/24V**

CODICE	VOLT	COLORE	MISURE	CF. 
OSR9856-12BI	12V	BIANCO	4x10mm	5mt.
OSR9856-12BL	12V	BLU	4x10mm	5mt.
OSR9856-12V	12V	VERDE	4x10mm	5mt.
OSR9856-12R	12V	ROSSO	4x10mm	5mt.
OSR9856-24BI	24V	BIANCO	4x10mm	5mt.
OSR9856-24BL	24V	BLU	4x10mm	5mt.
OSR9856-24V	24V	VERDE	4x10mm	5mt.
OSR9856-24R	24V	ROSSO	4x10mm	5mt.



## ALIMENTATORI

**OSR9865**

1 pz. 



Alimentatore da 0 -> 30 VDC massimo **5AMP** per strisce di luce continua.  
Consente la regolazione d'intensità luminosa (luce soffusa) delle strisce LED.  
Utilizzabile anche per strisce LED o dispositivi a **12V** su impianti a **24V**

Marchio Guidoni.

**OSR9866**

1 pz. 



Elevatore di tensione da 5 -> 30 VDC  
**12/24V**  
massimo **3AMP**

**OSR9867**

1 pz. 



Potenzimetro elettronico **3AMP**  
**12/24V** può regolare l'intensità luminosa o il numero di giri sui motorini in C.C

## FANALINI INGOMBRO LED CON CAVO 500 MM



Fanali LED **12-24V** di ingombro, con cavo da 500mm.

Ottima qualità e facile montaggio.

Marchio Guidoni.

CODICE	POSIZIONE	CARATTERISTICA	COLORE	CF. 
IND8469	Laterale	Cavo con staffa	<b>ARANCIO</b>	<b>1PZ.</b>
IND8470	Laterale	Cavo	<b>ROSSO</b>	<b>1PZ.</b>
IND8471	Laterale	Cavo	<b>BIANCO</b>	<b>1PZ.</b>

## 7- Fanalini ingombro LED

### FANALINI DI POSIZIONE CON CAVO 500 MM



Fanali LED **12-24V** di posizione, con cavo da **500mm**.  
ottima qualità e facile montaggio.

Marchio Guidoni.

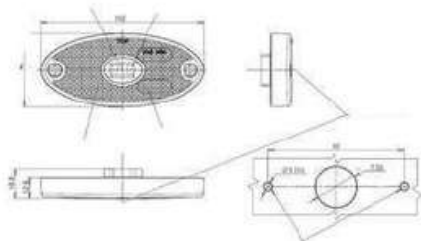

CODICE	POSIZIONE	CARATTERISTICA	COLORE	CF. 
IND8472	Laterale	Cavo 500mm click-in con staffa	ARANCIO	1PZ.
IND8472E	Laterale	SENZA click-in con staffa	ARANCIO	1PZ.
IND8473	Laterale	Cavo 500mm click-in	BIANCO	1PZ.
IND8474	Laterale	Cavo 500mm click-in	ROSSO	1PZ.

### FANALINI DI INGOMBRO LED CON CAVO 220 MM



Fanali LED **12-24V** di ingombro, con cavo da **220mm**.

Ottima qualità e facile montaggio.

Marchio Guidoni.

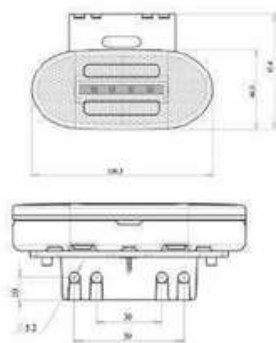

CODICE	POSIZIONE	CARATTERISTICA	COLORE	CF. 
IND8461	Laterale	Cavo con staffa	ARANCIO	1PZ.
IND8464	Posteriore	Cavo con staffa	ROSSO	1PZ.
IND8462	Anteriore	Cavo con staffa	BIANCO	1PZ.

### FANALINI DI POSIZIONE CON CAVO 500 MM



Fanali LED **12-24 VOLT**, con cavo da **500mm**.

Click-in di posizione laterali.

Marchio Guidoni.

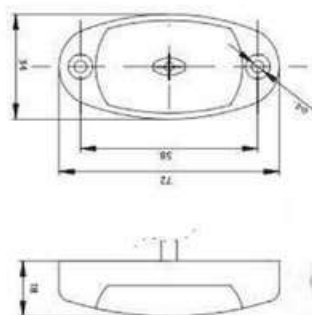

CODICE	POSIZIONE	CARATTERISTICA	COLORE	CF. 
IND8630	Anteriore	Fanalino ingombro LED Base piana con cavo 50cm e click-in	BIANCO	1PZ.
IND8631	Laterale	Fanalino ingombro LED Base piana con cavo 50cm e click-in	ARANCIO	1PZ.
IND8632	Posteriore	Fanalino ingombro LED Base piana con cavo 50cm e click-in	ROSSO	1PZ.



## 7- Fanalini ingombro LED

### FANALINI INGOMBRO LED

Fanalini ingombro LED **12/24V** ovale 3 funzioni con base piana, staffa verticale e piegata, ottima qualità e facile montaggio.

Marchio Guidoni.

**IND8636** 1 pz. 



Base piana,  
misure: 40X150mm

Marchio Guidoni

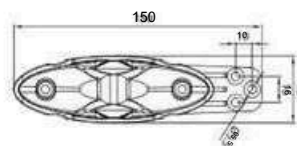
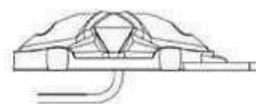

**IND8637** 1 pz. 



Staffa verticale

misure:

Marchio Guidoni

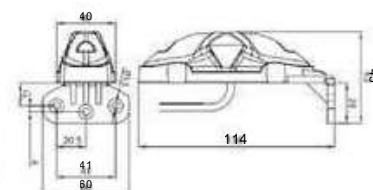

**IND8638** 1 pz. 



Staffa piegata  
misure:

Marchio Guidoni

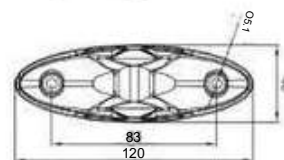
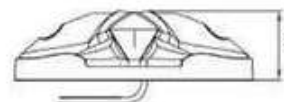

### FANALINI CATARIFRANGENTI

dettagli articoli

Fanali LED serie catarifrangente di posizione laterali, forma rettangolare.  
**12-24V**, cavo **500mm**



CODICE	MISURE	POSIZIONE	CARATTERISTICA	LED	COLORE	CF. 
IND8476	130X32x20mm,	Laterale	CON click-in e staffa	2	ARANCIO	1PZ.
IND8476E	130X32x20mm,	Laterale	SENZA click-in e con staffa	3	ARANCIO	1PZ.
IND8475	130X32x20mm,	Laterale	CON click-in e staffa	2	ARANCIO	1PZ.
IND8477	130X32x20mm,	Laterale	CON click-in e staffa	1	ROSSO	1PZ.
IND8477E	130X32x20mm,	Laterale	SENZA click-in e con staffa	3	ROSSO	1PZ.
IND8478	130X32x20mm,	Laterale	CON click-in e staffa	1	BIANCO	1PZ.
IND8478E	130X32x20mm,	Laterale	SENZA click-in e con staffa	3	BIANCO	1PZ.



## FANALINI LED CON CAVO CLICK-IN



[dettagli articoli](#)

Fanali LED **12-24VOLT**  
con cavo 50cm e click-in.  
Ottima qualità e facile montaggio.

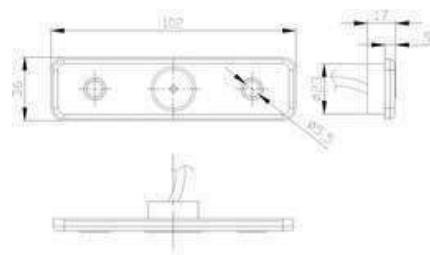

CODICE	POSIZIONE	CARATTERISTICA	COLORE	CF.
IND8634	Anteriore	con cavo 50cm e click-in	<b>BIANCO</b>	<b>1PZ.</b>
IND8633	Laterale	con cavo 50cm, click-in e staffa	<b>ARANCIO</b>	<b>1PZ.</b>
IND8635	Posteriore	con cavo 50cm e click-in	<b>ROSSO</b>	<b>1PZ.</b>

## FANALINO INGOMBRO LED ADESIVO

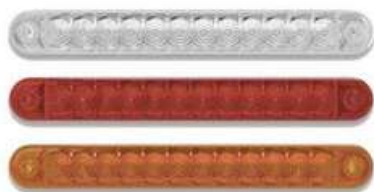

[dettagli articoli](#)

Fanalino LED ingombro **12/24V** con adesivo e cavo **50cm, 22,5X8cm**  
Ottima qualità e facile montaggio

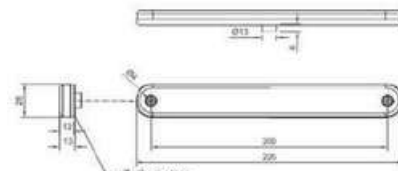

CODICE	POSIZIONE	CARATTERISTICA	COLORE	CF.
IND8639	Anteriore	cavo 50cm, misure: 22,5X8cm	<b>BIANCO</b>	<b>1PZ.</b>
IND8640	Posteriore	cavo 50cm, misure: 22,5X8cm	<b>ROSSO</b>	<b>1PZ.</b>
IND8641	Laterale	cavo 50cm, misure: 22,5X8cm	<b>ARANCIO</b>	<b>1PZ.</b>



[dettagli articoli](#)

Fanalino LED **12/24V**  
Ottima qualità e facile montaggio



CODICE	MISURE	FUNZIONE	COLORE	CF.
IND8627	236x20,6x10,4 mm	Freccia dinamica	<b>ARANCIO</b>	<b>1PZ.</b>
IND8628	236x20,6x10,4 mm	freccia dinamica, posizione, stop	<b>ARANCIO</b>	<b>1PZ.</b>
IND8629	236x20,6x10,4 mm	posizione, stop	<b>ROSSO</b>	<b>1PZ.</b>

## 7- fanali ingombro LED



**IND8489**    **IND8491**    **IND8490**    1 pz.

**COLORE**    **COLORE**    **COLORE**  
**ARANCIO**    **BIANCO**    **ROSSO**

[dettagli articoli](#)

Fanalino laterale side marker 6 LED 24V  
**misure:** 96x 15mm



**IND8492A**    **IND8492B**    **IND8492R**    1 pz.

**COLORE**    **COLORE**    **COLORE**  
**ARANCIO**    **BIANCO**    **ROSSO**

[dettagli articoli](#)

Fanalino LED laterale 12/24V side marker con  
cavo **20cm**  
**misure:** 60x38mm  
interasse fori: 50mm



**IND8493A**    **IND8493B**    **IND8493R**    1 pz.

**COLORE**    **COLORE**    **COLORE**  
**ARANCIO**    **BIANCO**    **ROSSO**

[dettagli articoli](#)

Fanalino LED laterale tondo 12/24V side marker  
con cavo **13cm**  
diametro **20mm**  
profondità **21mm**

[dettagli articoli](#)



CODICE	VOLT	MISURE	COLORE	CF.
IND8642	12/24V	31,2x110x22,5mm	ARANCIO	1pz.
IND8643	12/24V	31,2x110x22,5mm	ROSSO	1pz.
IND8644	12/24V	31,2x110x22,5mm	BIANCO	1pz.
IND8645	12/24V	31,2x110x22,5mm	VERDE	1pz.
IND8646	12/24V	31,2x110x22,5mm	BLU	1pz.

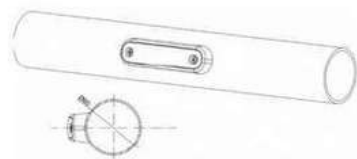

**IND8647**    4 pz.

Supporto per montaggio su griglie tubolari

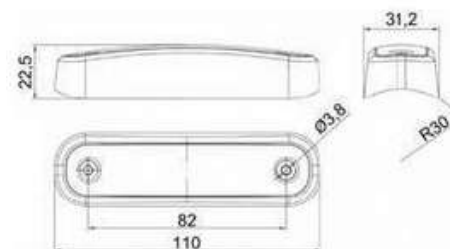

## 7- fanali ingombro LED

### dettagli articoli

Fanalino ingombro LED **12/24V**

**misure:** 120x46x18 mm



CODICE	DESCRIZIONE	COLORE	CF.
IND8648	Con cavo 0,5mt	ARANCIO	1PZ.
IND8648E	Con staffa più	ARANCIO	1PZ.
IND8649	Con cavo 0,5mt	ROSSO	1PZ.
IND8649E	Con connessione	ROSSO	1PZ.
IND8650	Cavo 0,5mt	BIANCO	1PZ.
IND8650E	Con connessione	BIANCO	1PZ.

**IND8651**

4 pz.

Staffa con fissaggio ad angolo 90°

### FANALI DI INGOMBRO "FUORI SAGOMA"



**IND8407**

4 pz.

Fanali LED **24V** con cavo **400mm**, N° LED8, di ingombro **rosso**/bianco ingresso dritto.

Marchio Guidoni.



**IND8408**

4 pz.

Fanali LED **24V** con cavo **400mm**, N° LED8, di ingombro **rosso**/bianco ingresso a bandiera.

Marchio Guidoni.



**IND 8480**

4 pz.

Fanalino LED **12-24V** di ingombro  
-**misure:** 84X103X33mm  
-colore bianco/**rosso**/**arancione**

Marchio Guidoni.



**IND8481**

**IND8482**

1 pz.

Laterale  
destro

Laterale  
sinistro

Fanalino LED **12-24V** di ingombro

**misure:** 135x114x37mm

Marchio Guidoni.



## 7- fanali ingombro LED



**IND8483**      **IND8484**      1 pz.

laterale      laterale  
destro      sinistro

Fanalino LED **12-24V** di ingombro

**misure:** 154x165x37mm

Marchio Guidoni.

### FANALINI LATERALE INGOMBRO 3 LED



Fanalini laterali da ingombro 3 LED  
con cavo 50cm e CLICK-IN.  
Ottima qualità e facile montaggio.

**12/24V**



CODICE	POSIZIONE	COLORE	CF.
IND8485	laterale sinistra corto	BIANCO, ARANCIO, ROSSO	1pz.
IND8486	laterale destra corto	BIANCO, ARANCIO, ROSSO	1pz.
IND8487	laterale sinistra lungo	BIANCO, ARANCIO, ROSSO	1pz.
IND8488	laterale destra lungo	BIANCO, ARANCIO, ROSSO	1pz.

### FANALINI PER LUCI TARGA



**IND8411L**      2 pz.

Fanalino targa LED 12/24V

**misure:** 82,5x39mm,

cavo 200m IP67



**IND8410**      2 pz.

Fanalino targa LED 12/24V **ROSSO** con posizione  
con cavo 50cm

**misure:** 109X55.5X61mm

IP67





### **IND8428**

con cavo e  
click-in

### **IND8428E**

con cavo  
senza click-in

2 pz.

#### **dettagli articoli**

Fanalini LED smd di posizione **neri** per targa

12-24V n° led 2

Marchio Guidoni.



### **IND8429**

con cavo e  
click-in

### **IND8429E**

con cavo  
senza click-in

2 pz.

#### **dettagli articoli**

Fanalini LED smd di targa e posizione **rosso**,

12-24V n° led 2

Marchio Guidoni.

## **FANALI LED POSTERIORI**



### **IND8423L**

1pz.

Fanale posteriore (tipo cobino) LED **12-24V**, forma rettangolare,  
**misure** 14,5x7,5cm  
Marchio Guidoni.



### **IND8527**

1pz.

Fanale posteriore LED **12/24V**  
**misure:** 105X95X38mm  
5 funzioni: Posizione, stop, freccia riflettente, luce targa  
**IP67**  
temperatura di esercizio: -20°->65°  
omologazione

ECE R10 R148 R150  
ROHS E9

Marchio Guidoni

### **IND8528**

1pz.

Fanale anteriore LED **12/24V**  
misure: 105X95X38  
3 funzioni: posizione, freccia, riflettente **IP67**  
temperatura di esercizio: -20°->65°  
omologazione:

ECE R10 R148 R150  
ROHS E9

Marchio Guidoni



## 7- fanali posteriori



**IND8442**

1pz.

Fanale posteriore,  
misure:105mmx95mm  
LED 10/30V  
IP 67  
3 funzioni: posizione, stop,  
freccia  
omologazione: ECE

Marchio Guidoni

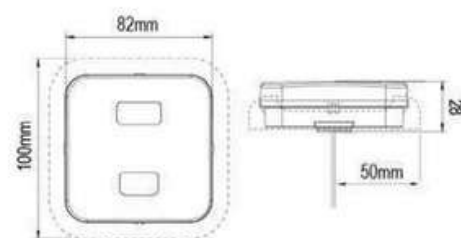

**IND8443**

1pz.

Fanale anteriore,  
misure:105mmx95mm  
LED 10/30V  
IP 67  
2 funzioni: posizione, freccia  
omologazione: ECE

Marchio Guidoni

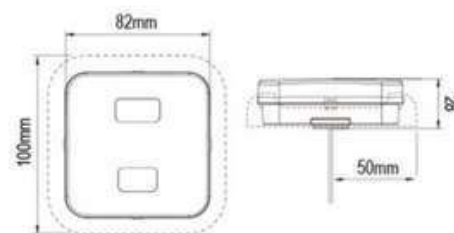

**IND8444**

1pz.

Fanale posteriore,  
misure:105mmx95mm  
LED 10/30V  
IP 67  
2 funzioni: retromarcia, retronebbia  
omologazione: ECE

Marchio Guidoni

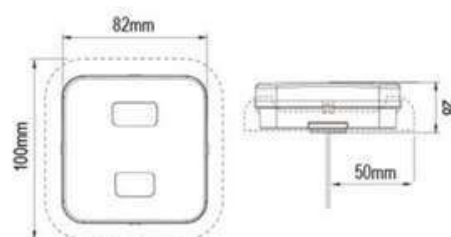

**IND8445    IND8446**

1 pz.

Retromarcia    Retronebbia  
**BIANCO    ROSSO**

Dettagli articoli:  
fanale posteriore,  
**misure:** 101x81mm LED 12/24V  
IP 67 retromarcia bianco

omologazione: ECE

Marchio Guidoni

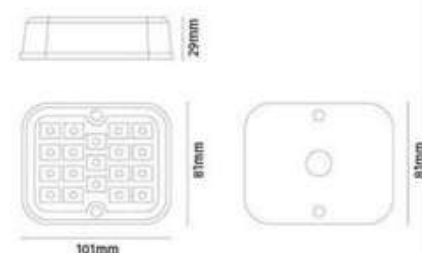

**IND8431**

1pz.

Kit impianto luci led **12w** wireless 4 funzioni .  
il kit comprende: 2 fanali led magnetici, 4 funzioni ricaricabili  
con usb, ricevitore integrato per carrelli e rimorchi **12V**.

Marchio Guidoni



## 7- fanali posteriori



**IND8431L**

1pz.

Fanali LED posteriori per bisarche, diametro 140mm  
**2 funzioni:** retromarcia, retronebbia **24V.**

Marchio Guidoni



**IND8432L**

1pz.

Fanali LED posteriori per bisarche, diametro 140mm  
**3 funzioni:** posizione, stop, indicatore di direzione **24V.**

Marchio Guidoni



**IND8530**

1pz.

Fanali LED posteriori **12/24V**  
misure: 220X100X34.4mm  
**5 funzioni:** Posizione, stop, freccia, retromarcia, retronebbia. interasse 152mm, 2viti M6 e cavo da 50cm  
**IP67**  
Temperatura di esercizio -20°->60°

omologazione:  
ECE R148 R150 R10 CE-RH0S

Marchio Guidoni



**IND8531**

1pz.

Fanali LED posteriori **12/24V**  
misure: 284X100X34.4mm  
**5 funzioni:** Posizione, stop, freccia, retromarcia, retronebbia. interasse 152mm, 2 viti M6 e cavo da 50cm  
**IP67**  
Temperatura di esercizio -20°->60°

omologazione:  
ECE R148 R150 R10 CE-RH0S

Marchio Guidoni

## FANALI LED POSTERIORI RIMORCHIO

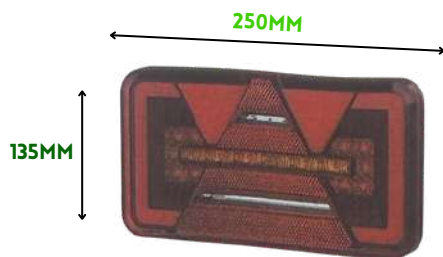

**IND8530R**

1pz.

Fanali LED posteriori rimorchio destro e sinistro **12/24V**  
misure: 250X135X36mm  
**5 funzioni:** Posizione, stop, freccia, retromarcia, retronebbia interasse 152mm, 2viti M6 e cavo da 50cm  
**IP67**  
Temperatura di esercizio -20°->60°

omologazione:  
ECE R148 R150 R10 CE-RH0S

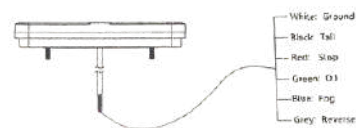

## IND8531R

1pz. 

Fanali LED posteriori rimorchio destro e sinistro **12/24V**

**misure:** 430X135X36mm

**5 funzioni:** Posizione, stop, freccia, retromarcia, retronebbia

interasse 152mm

2viti M6 e cavo da 50cm

IP67

Temperatura di esercizio -20°->60°

omologazione:

ECE R148 R150 R10 CE-RH0S

Marchio Guidoni

## FANALI POSTERIORI

### dettagli articoli

Lenti e fanali con attacco per connettore 4 pin, di posizione posteriore, con forma rettangolare per camion.

applicazioni: IVECO E UNIVERSALI

CODICE	POSIZIONE	MISURE	TIPO	CF. 
IND8414	posteriore sinistro	303X130mm	LENTE	1PZ.
IND8415	posteriore destro	303X130mm	LENTE	1PZ.
IND8416	posteriore sinistro	303X130mm	FANALE	1PZ.
IND8417	posteriore destro	303X130mm	FANALE	1PZ.

## IND8517

2 pz. 

Raccordo per fanali IND8416, IND8417

Marchio Guidoni.

## IND8523

## IND8524

1 pz. 

Destro

Sinistro

### dettagli articoli

Fanali posteriori con attacco per connettore 5 pin, applicazioni: IVECO daily 2000 (10/99 >06).

**misure:**303x130mm

## IND8438

## IND8439

1 pz. 

Destro

Sinistro

### dettagli articoli

Fanali posteriori con doppio connettore 3+10 pin applicazioni: IVECO eurocargo

**misure:**303x130mm



## 7- fanali posteriori



### dettagli articoli

Fanali posteriori con attacco per connettore 7 pin, applicazioni: IVECO daily ('06>) eurocargo ('06>).

**misure:**303x130mm

CODICE	POSIZIONE	MISURE	TIPO	CF.
IND8418	posteriore destro	303X130mm	FANALE	1PZ.
IND8419	posteriore sinistro	303X130mm	FANALE	1PZ.
IND8420	posteriore sinistro	303X130mm	LENTE	1PZ.
IND8421	posteriore destro	303X130mm	LENTE	1PZ.

**IND8532**    **IND8532LT**    **IND8533**    1 pz.

Fanale            Fanale            Lente  
DX-SX            SX                    DX-SX  
con luce targa



### dettagli articoli

Fanali posteriori con attacco per connettore 7 pin, con ghiera e pipetta in gomma.

**misure:**303x130mm

### dettagli articoli

Fanali posteriori con attacco per connettore 10 pin 7 funzioni.

applicazioni: iveco.

Marchio Guidoni.



CODICE	POSIZIONE	MISURE	TIPO	CF.
IND8455D	posteriore destro	466X130mm	FANALE	1PZ.
IND8455S	posteriore sinistro	466X130mm	FANALE	1PZ.
IND8456	posteriore sinistro, luce targa	466X130mm	FANALE	1PZ.
IND8466	posteriore	466X130mm	LENTE	1PZ.

**IND8704D**    **IND8704S**    **IND8704L**    1 pz.

Fanale            Fanale            Lente  
DX                SX                    DX-SX  
full LED        full LED



### dettagli articoli

Fanali posteriori full LED con attacco per connettore 10 pin 7 funzioni.

applicazioni: iveco.

Marchio Guidoni.



## 7- fanali posteriori



### dettagli articoli

Fanali posteriori con attacco per connettore 7 pin,

**Applicazione:** mercedes, actros  
**misure:** 522x141mm

Marchio Guidoni.



CODICE	TIPO	CF. 
IND8504	Fanale SX con luce targa	1PZ.
IND8505	Fanale DX	1PZ.
IND8510	Lente posteriore SX	1PZ.
IND8511	Lente posteriore SX	1PZ.

## FANALI POSTERIORI RIMORCHIO

### EUROPOINT 1

#### dettagli articoli

Fanali posteriori rimorchio con triangolo tipo ASPOCK  
europoint 1  
con attacco per connettore 7 pin.

Marchio Guidoni.



CODICE	POSIZIONE	MISURE	TIPO	CF. 
IND8506	posteriore destro,	421X147mm	FANALE	1PZ.
IND8507	posteriore sinistro,	421X147mm	FANALE	1PZ.
IND8500	posteriore DX/SX	421X147mm	LENTE	1PZ.

### EUROPOINT 2

Fanali posteriori rimorchio con triangolo tipo ASPOCK  
europoint 2  
con attacco per connettore 7 pin.

**A**



**B**



**C**



CODICE	CODICE ORIGINALE	TIPO	FIGURA
IND8784S	256000501	FANALE SX	A
IND8784D	256400501	FANALE DX	A
IND8785S	256021701	FANALE SX con luce ingombro	B
IND8785D	256041701	FANALE DX con luce ingombro	B
IND8784L	188560002	LENTE DX/SX	C



## 7- fanali posteriori

### EUROPOINT 3

Fanali posteriori rimorchio con triangolo tipo ASPOCK  
europoint 3  
con attacco per connettore 7 pin.



CODICE	CODICE ORIGINALE	TIPO	FIGURA
IND8786S	257000501	FANALE SX	A
IND8786D	257400501	FANALE DX	A
IND8787S	257020501	FANALE SX con luce ingombro	B
IND8787D	257420501	FANALE DX con luce ingombro	B
IND8786LS	188570101	LENTE SX	C
IND8786LD	188570001	LENTE DX	C

### RACCORDI POSTERIORI UNIVERSALI KRONE



CODICE	TIPO	DESCRIZIONE	FIGURA
IND8788D	FANALE DX	universale KRONE	A
IND8788S	FANALE SX	universale KRONE	A
IND8789D	FANALE DX	universale KRONE con luce ingombro	B
IND8789S	FANALE SX	universale KRONE con luce ingombro	B
IND8790D	FANALE DX	universale KRONE con posizione stop a LED	C
IND8790S	FANALE SX	universale KRONE con posizione stop a LED	C
IND8788LD	LENTE DX	universale KRONE	D
IND8788LS	LENTE SX	universale KRONE	D



## UNIVERSALI

### dettagli articoli



Fanale full LED universale. canbus integrato. tensione 24V, connettore CON2243 7 vie, interasse perni 152mm

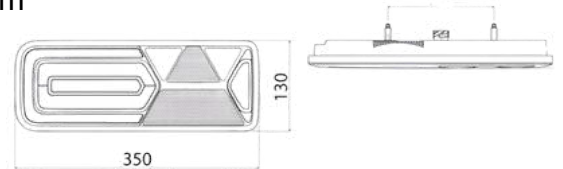

CODICE	POSIZIONE	TIPO	CF.
IND8780	Fanale SX	MOTRICE	1PZ.
IND8781	Fanale DX	MOTRICE	1PZ.
IND8782	Fanale SX	RIMORCHIO con triangolo	1PZ.
IND8783	Fanale DX	RIMORCHIO con triangolo	1PZ.



**CON2243** 2pz.

Connettore per fanali 7 poli, tipo di contatto femmina

## IVECO

**IND8700** **IND8701** 1pz.

Fanale full LED SX

Fanale full LED DX

### dettagli articoli

Fanale full LED posteriore. iveco strolls/trakker. 24V, connettore hdscs 8 vie CON2277 interasse 152mm

**IND8702** **IND8703** 1pz.

Lente SX per fanale full LED iveco stralis /trukker

Lente DX per fanale full LED iveco stralis /trukker



**CON2277** 1pz.

Connettore per fanale 8 poli, tipo di contatto femmina

## VOLVO

**IND8740**

**IND8741**

1pz. 



Fanale full LED  
SX

Fanale full LED  
DX

dettagli articoli

Fanale full LED destro **con luce targa**  
volvo fh 12.2012 24V, connettore  
CON2243,  
1,5AMP, 7 vie laterale  
interasse 160 mm.

**IND8743**

**IND8744**

1pz. 



Fanale full LED  
SX

Fanale full LED  
DX

dettagli articoli

Fanale full LED **con luce targa**  
volvo fm 09.2013 24V,  
connettore CON2243,  
interasse 160 mm.

**IND8742**

**IND8745**

1pz. 



Lente DX/SX  
per fanale full LED  
volvo fh 12.2012  
24V

Lente DX/SX  
per fanale full LED  
volvo fm 09.2013  
24V

## MERCEDES

**IND8760**

**IND8761**

1pz. 



Fanale full LED  
sinistro

Fanale full LED  
destro

dettagli articoli

Fanale full LED mercedes sprinter/pick-up 2006  
12v, connettore CON2243,  
1,5 AMP, posteriore a 7 vie

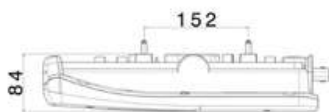
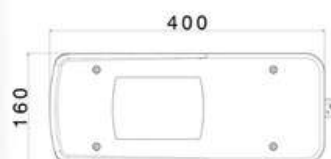

### MAN



**IND8770** 1pz.

Lente sinistra man tge/tga/tgl/tgm/tgx 2005

**IND8771** 1pz.

Lente destra man tge/tga/tgl/tgm/tgx 2005

### SCANIA



**IND8720** **IND8721** 1pz.

Fanale posteriore  
SX

Fanale posteriore  
DX

#### dettagli articoli

Fanale posteriore **con luce targa** scania serie iv p-r  
**12-24V**, connettore CON2243,  
1,5AMP, interasse 152mm  
**connettore posteriore**

**IND8722** **IND8723** 1pz.

Fanale posteriore  
SX

Fanale posteriore  
DX

#### dettagli articoli

Fanale posteriore **con luce targa** scania serie iv p-r  
**12-24V**, connettore CON2243,  
1,5AMP, interasse 152mm  
**connettore laterale**



**IND8724** **IND8725** 1pz.

Lente posteriore  
SX

Lente posteriore  
DX

Lenti per fanali posteriore scania serie iv p-r dal 2007->



### CONNETTORI PORTA LAMPADA SERIE T 10



**IND8395** 10 pz. 

Connettore porta lampada serie t10

Marchio Guidoni



**IND8396** 10 pz. 

Connettore porta lampada serie t10 cablato

Marchio Guidoni



**IND8398** 10 pz. 

Connettore porta lampada serie t10 mini timer

Marchio Guidoni



**IND8401** 10 pz. 

Connettore porta lampada serie t10 superseal, di  
posizioni laterali

Marchio Guidoni

### CONNETTORI PORTA LAMPADA SERIE H6



**IND8399** 10 pz. 

Connettore porta lampada cablato attacco ba9s

Marchio Guidoni

### CONNETTORI PORTALAMPADA BA 15S



**IND8400** 10 pz. 

Connettore porta lampada attacco ba15s

Marchio Guidoni

### RACCORDI PER FANALI CON ATTACCO 7 PIN



**IND8514**

1pz.

KIT connettore 7 VIE porta femmina **giallo** ASS2 per fanali ASPOCK a vite e baionetta



**IND8513**

1pz.

KIT connettore 7 VIE porta femmina **verde** ASS2 per fanali ASPOCK a vite e baionetta



**IND8512**

1pz.

KIT connettore 7 VIE porta femmina **verde/giallo** ASS2 per fanali ASPOCK a vite e baionetta



**IND8521**

1pz.

KIT connettore 7 VIE porta femmina per fanali posteriori HELLA EASY CONN



**CON2243G**

1pz.

KIT connettore 7 VIE grigio per autocarri



**CON2250**

1pz.

KIT connettore 4 VIE porta femmina ghiera grigia per sensore e elettrovalvola truck

