

# FUSIBILI

3

## E PORTAFUSIBILI



### CAPITOLO 3

- Fusibili e Portafusibili
- Moduli, Frames e Accessori



FUSIBILI

E PORTAFUSIBILI





### 3- fusibili e portafusibili

#### FUSIBILI LAMELLARI UNI E UNI LED

Fusibili serie uni lamellari e uni led, I modelli led ti segnalano quando il fusibile ha un malfunzionamento illuminandosi,

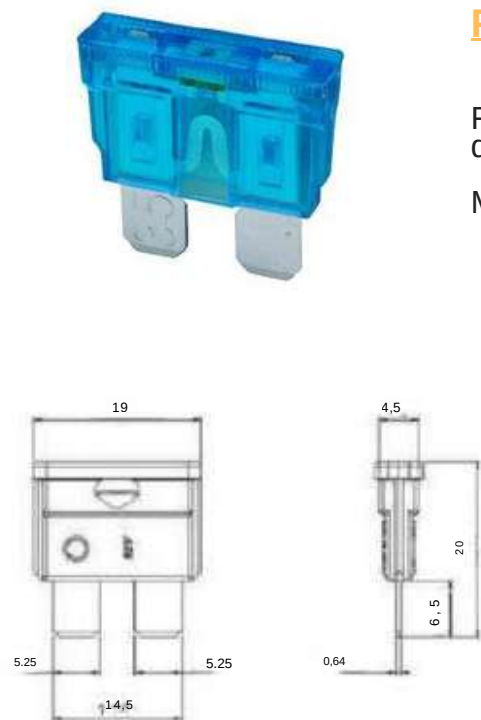
Marchio Guidoni.



CODICE KIT	AMPERE	COLORE	TIPO	CF. 
FUS4001	1A	NERO		100PZ.
FUS4002	2A	GRIGIO		100PZ.
FUS4003	3A	VIOLA		100PZ.
FUS4004	4A	ROSA		100PZ.
FUS4005	5A	BEIGE		100PZ.
FUS4006	7,5A	MARRONE		100PZ.
FUS4007	10A	ROSSO		100PZ.
FUS4008	15A	BLU		100PZ.
FUS4009	20A	GIALLO		100PZ.
FUS4010	25A	TRASPARENTE		100PZ.
FUS4011	30A	VERDE		100PZ.
FUS4012	40A	ARANCIONE		100PZ.
FUS4050	2A	GRIGIO	LED	50PZ.
FUS4051	3A	VIOLA	LED	50PZ.
FUS4052	4A	ROSA	LED	50PZ.
FUS4053	5A	BEIGE	LED	50PZ.
FUS4054	7,5A	MARRONE	LED	50PZ.
FUS4055	10A	ROSSO	LED	50PZ.
FUS4056	15A	AZZURRO	LED	50PZ.
FUS4057	20A	GIALLO	LED	50PZ.
FUS4058	25A	TRASPARENTE	LED	50PZ.
FUS4059	30A	VERDE	LED	50PZ.
FUS4060	35A	VERDE SCURO	LED	50PZ.
FUS4061	40A	ROSSO SCURO	LED	50PZ.

#### KIT FUSIBILI UNI



##### FUS4014

Kit fusibili serie uni tipo lamellari - marchio guidoni In un box in plastica, troverai un totale di 110 fusibili lamellari:

- 10 da 3 ampere,
- 10 da 4 ampere,
- 10 da 5 ampere,
- 10 da 7,5 ampere,
- 10 da 10 ampere,
- 10 da 15 ampere,
- 10 da 20 ampere,
- 10 da 25 ampere,
- 10 da 30 ampere,
- 10 da 40 ampere

##### articoli correlati

FUS 4099  
FUS4468  
FUS 4119



#### FUSIBILI LAMELLARI 80V



- **materiale:** Rame stagnato
- Adatto per l'uso di applicazioni a bassa tensione fino a 80v DC
- Capacità di rottura 1000A A 80V DC
- Controllare il fusibile nel blocco fusibile utilizzando i punti di prova in cima al fusibile
- Rigidità nella lama grazie alla costruzione

Marchio Guidoni.

CODICE	AMPERE	COLORE	CF. 
FUS4003-80	3A	VIOLA	10PZ.
FUS4004-80	4A	ROSA	10PZ.
FUS4005-80	5A	BEIGE	10PZ.
FUS4006-80	7,5A	MARRONE	10PZ.
FUS4007-80	10A	ROSSO	10PZ.
FUS4008-80	15A	BLU	10PZ.
FUS4009-80	20A	GIALLO	10PZ.
FUS4010-80	25A	BIANCO	10PZ.
FUS4011-80	30A	VERDE	10PZ.



#### FUSIBILI RIPRISTINABILI



Fusibili ripristinabili uni, sono in grado di garantirti il massimo controllo grazie all'interruttore termico automatico.

Marchio Guidoni.

CODICE	AMPERE	COLORE	CF. 
FUS4036	5A	BEIGE	1 PZ.
FUS4030	7,5A	MARRONE	1 PZ.
FUS4031	10A	ROSSO	1 PZ.
FUS4032	15A	BLU	1 PZ.
FUS4033	20A	TRASPARENTE	1 PZ.
FUS4034	25A	GIALLO	1 PZ.

#### **FUS4037**

Kit fusibili uni-ripristinabili uni fuse circuit breaker, Marchio Guidoni.

Kit composto da:

- FUS4030
- FUS4031
- FUS4032
- FUS4033
- FUS4034
- FUS4035



## 3- fusibili e portafusibili

### FUSIBILI UNI CON DERIVAZIONE



Fusibili uni muniti di un cavo di derivazione che ti permetterà di aggiungere una linea di corrente ed aumentare i collegamenti del tuo impianto.

Marchio Guidoni.

CODICE	AMPERE	COLORE	CF	
FUS4017	10	ROSSO	1 PZ.	
FUS4018	15	BLU	1 PZ.	
FUS4019	20	GIALLO	1 PZ.	
FUS4020	25	TRASPARENTE	1 PZ.	
FUS4021	30	VERDE	1 PZ.	

### PORTA FUSIBILI UNI CON DERIVAZIONE

Portafusibili per fusibili uni 2 vie.

Marchio Guidoni.



CODICE	CF.	
FUS4022	2 PZ.	
FUS4022/10	10 PZ.	

### COPERCHI PORTAFUSIBILI UNI



**FUS4501** 25 pz. 

Coperchio serie uni tipo lamellari per portafusibili 1 via,

Marchio Guidoni.

**articoli correlati**

FUS4524

FIS3004

### PORTAFUSIBILI UNI COMPONENTI



**FUS4500** 25 pz. 

Portafusibili componibili serie uni tipo lamellari 1 via,

Marchio Guidoni.

**articoli correlati**

FUS 4500

### PORTAFUSIBILI CON USCITE LATERALI



**FUS4524** 25 pz. 

Portafusibili componibili serie uni uscite laterali tipo lamellari 1 via,

marchio Guidoni.

**articoli correlati**

FUS4510

FUS4500

FUS4506



### PORTAFUSIBILI UNI PER FIAT



#### FUS4506

25 pz. 

Portafusibili componibili serie uni tipo lamellari 1 via,

Marchio mta per fiat.

#### **articoli correlati**

TER1333

TER133

FIS3020

#### FUS4507

25 pz. 



portafusibili componibili serie uni tipo lamellari 1 via,

Marchio mta per fiat nuovo tipo.

#### **articoli correlati**

TER 1333

TER 1334

### PORTAFUSIBILI UNI DA INCASSO



#### FUS4543

2 pz. 

Portafusibili elettrici con led 1 via da incasso,

Marchio Guidoni.

### PORTAFUSIBILI UNI STAGNI



#### FUS4504

10 pz. 

Kit portafusibile 2 vie tenuta stagna per cavo ->10MMQ  
portata massima 60AMP (40+40)



#### FUS4505

sezione cavo  
4mm<sup>2</sup>

#### FUS4505-25

sezione cavo  
2,5mm<sup>2</sup>

#### FUS4505-15

sezione cavo  
1,5mm<sup>2</sup>

10pz. 

#### dettagli articoli

Portafusibili a tenuta stagna, volanti serie uni per fusibili tipo lamellari

### 3- fusibili e portafusibili



**FUS4505L**

5 pz.

Portafusibili led stagni volanti 1 via per fusibili uni lamellari, sezione cavo 4mm<sup>2</sup>  
Marchio Guidoni.

**articoli correlati**

FUS 4530  
FUS4505  
FUS4524



**FUS4544**

2 pz

Portafusibile stagno per fusibili ato

Marchio Guidoni.



**FUS4537**

5 pz.

Portafusibili a tenuta stagna per fusibili ATO

Marchio Guidoni.

### PORTAFUSIBILI DA INCASSO



**FUS4517**

2 pz

Portafusibili serie uni da incasso tipo lamellari 8 vie,  
Marchio mta.

**articoli correlati**

FUS 4519  
FUS 4523  
FUS 4518

### PORTAFUSIBILI UNI CON USCITE LATERALI



**FUS4554**

2pz

Portafusibile serie uni 2 vie uscite laterali per fusibili ATO

42x55x52.5

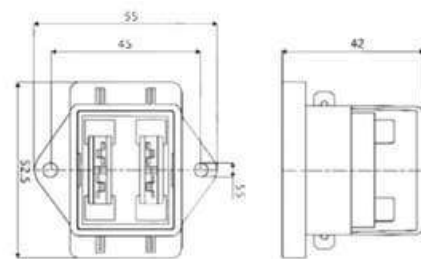

**FUS4555**

2pz

Portafusibile serie uni 4 vie uscite laterali per fusibili ATO



### 3- fusibili e portafusibili



**FUS4556**

1pz

Portafusibile serie uni 6 vie uscite laterali per fusibili ATO

42x115.5x52.5

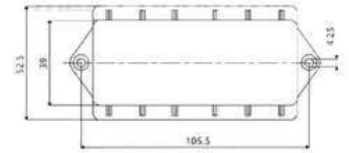
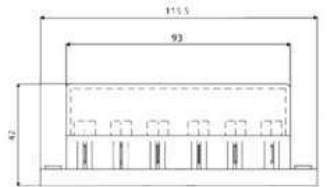

**FUS4557**

1pz

Portafusibile serie uni 8 vie uscite laterali per fusibili ATO



**FUS4558**

1pz

Portafusibile serie uni 10 vie uscite laterali per fusibili ATO

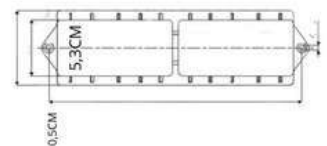
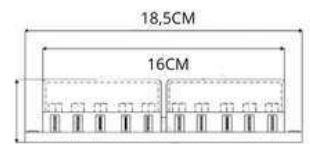

**FUS4559**

1pz

Portafusibile serie uni 12 vie uscite laterali per fusibili ATO  
41x212x52.5

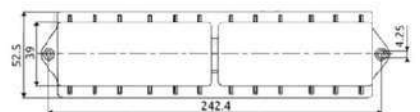
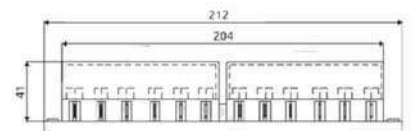

### PORTAFUSIBILI CON USCITE ASSIALI



**FUS4519**

2 pz

Portafusibili serie uni uscite assiali tipo lamellari 4 vie,  
Marchio mta.

**articoli correlati**

FUS 4523  
FUS4518  
FUS4517



**FUS4521**

2 pz

Portafusibili serie uni uscite assiali tipo lamellari 6 vie,  
Marchio mta.

**articoli correlati**  
FUS 4523  
FUS4522  
FUS4517



### PORTAFUSIBILI UNI LED



**FUS4540**

1 pz 

Portafusibili serie uni led tipo lamellari 4 vie, in caso di fusibile bruciato si accende il led corrispondente.

Marchio Guidoni.

**articoli correlati**

FUS4519  
FUS4518  
FUS 4545



**FUS4541**

1 pz 

Portafusibili , serie uni led tipo lamellari 6 vie, in caso di fusibile bruciato si accende il led corrispondente, Marchio Guidoni.

**articoli correlati**

FUS4546  
FUS4521  
FUS 4522



**FUS4542**

1 pz 

Portafusibili, serie uni led tipo lamellari 10 vie, in caso di fusibile bruciato si accende il led corrispondente, Marchio Guidoni.

**articoli correlati**

FUS4527  
FUS4547  
FUS4512



### KIT PORTAFUSIBILE CON POSITIVO IN COMUNE



**FUS4553**

1 pz 

Kit portafusibili a 8 vie per fusibili ATO massimo voltaggio 32VDC 100 ampere-positivo in comune



**FUS4553-4**

1 pz 

Kit portafusibili a 4 vie per fusibili ATO massimo voltaggio 32VDC 100 ampere-positivo in comune





## 3- fusibili e portafusibili

### FUSIBILI MINI E MINI LED

Fusibili mini lamellari e mini led lamellari. I modelli led segnalano quando il fusibile ha un malfunzionamento illuminandosi.

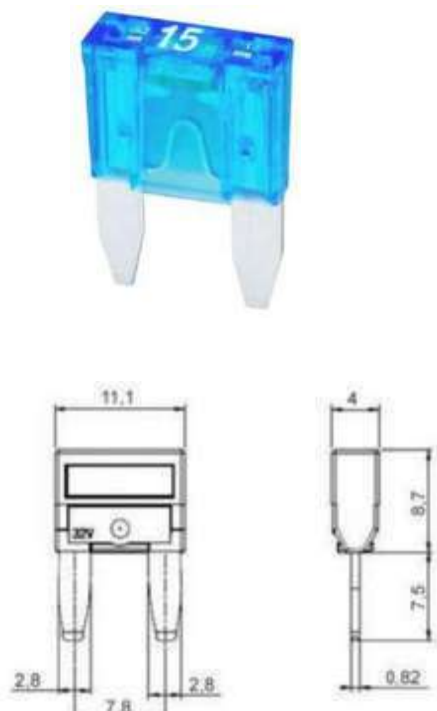
Marchio Guidoni.



CODICE	AMPERE	COLORE	TIPO	CF. 
FUS4109	2A	GRIGIO		50 PZ.
FUS4110	3A	VIOLA		50 PZ.
FUS4111	4A	ROSA		50 PZ.
FUS4112	5A	BEIGE		50 PZ.
FUS4113	7,5A	MARRONE		50 PZ.
FUS4114	10A	ROSSO		50 PZ.
FUS4115	15A	BLU		50 PZ.
FUS4116	20A	GIALLO		50 PZ.
FUS4117	25A	TRASPARENTE		50 PZ.
FUS4118	30A	VERDE		50 PZ.
FUS4062	2A	GRIGIO	LED	20 PZ.
FUS4063	3A	VIOLA	LED	20 PZ.
FUS4064	4A	ROSA	LED	20 PZ.
FUS4065	5A	BEIGE	LED	20 PZ.
FUS4066	7,5A	MARRONE	LED	20 PZ.
FUS4067	10A	ROSSO	LED	20 PZ.
FUS4068	15A	BLU	LED	20 PZ.
FUS4069	20A	GIALLO	LED	20 PZ.
FUS4070	25A	TRASPARENTE	LED	20 PZ.
FUS4071	30A	VERDE	LED	20 PZ.

### KIT FUSIBILI MINI

#### FUS4119

Kit fusibili, serie mini tipo lamellari troverai un totale di 155 pezzi dei seguenti mini fusibili:

5 fusibili mini da 3 ampere,  
 5 da 3 ampere,  
 10 da 5 ampere,  
 10 da 5 ampere,  
 25 da 10 ampere,  
 25 da 15 ampere,  
 25 da 20 ampere,  
 25 da 25 ampere,  
 25 da 30 ampere



Marchio Guidoni

#### articoli correlati

FUS4140  
 FUS4467  
 FUS4468



### 3- fusibili e portafusibili

#### FUSIBILI MINI RIPRISTINABILI

Fusibili ripristinabili mini-lamellari dotati di un' interruttore termico unipolare e in grado di staccare in caso di sovracorrenti, per poi ritornare in posizione di riposo, e permettere nuovamente il corretto funzionamento del circuito.

Marchio Guidoni.



CODICE	AMPERE	COLORE	CF 
FUS4040	5A	BEIGE	1 PZ.
FUS4041	7,5A	MARRONE	1 PZ.
FUS4042	10A	ROSSO	1 PZ.
FUS4043	15A	BLU	1 PZ.
FUS4044	20A	GIALLO	1 PZ.
FUS4045	25A	TRASPARENTE	1 PZ.
FUS4046	30A	VERDE	1 PZ.

#### FUSIBILI MINI CON DERIVAZIONE

Fusibili mini lamellari con cavo di derivazione protettivo e isolante  
Marchio Guidoni.



CODICE	AMPERE	COLORE	CF 
FUS4124	10	ROSSO	5 PZ.
FUS4125	15	BLU	5 PZ.
FUS4126	20	GIALLO	5 PZ.
FUS4127	25	TRASPARENTE	5 PZ.
FUS4128	30	VERDE	5 PZ.

#### FUSIBILI MINICON TERMINALE DI PRESA DI CORRENTE

CODICE	AMPERE	COLORE	CF 
FUS4159	3	VIOLA	5 PZ.
FUS4160	5	OCRA	5 PZ.
FUS4161	7,5	ARANCIONE	5 PZ.
FUS4162	10	ROSSO	5 PZ.
FUS4163	40	CELESTE	5 PZ.
FUS4164	20	GIALLO	5 PZ.
FUS4165	25	GRIGIO	5 PZ.
FUS4166	30	VERDE	5 PZ.



MARCHIO  
GUIDONI.





#### FUS4167

Assortimento fusibili mini con terminale di presa di corrente

**Applicazioni:**  
fusibili mini, vari amperaggi con terminale di presa di corrente FUS4167 Kit assortimento

### PORTAFUSIBILI MINI CON DERIVAZIONE



**FUS4029** 2 pz 

**FUS4029/10** 10 pz 

I portafusibili mini lamellari Guidoni con derivazione, che consente l'aggiunta di due linee di corrente al tuo impianto. Questo tipo di portafusibili ti darà la possibilità di inserire un secondo mini fusibile per una protezione ottimale dagli sbalzi di corrente.

Marchio Guidoni.

### PORTAFUSIBILI MINI

**FUS4508** 10 pz 



Portafusibili componibili serie mini Marchio Guidoni.

#### articoli correlati

FUS 4527  
TER 1321  
FUS4512



**FUS4537M** 5 pz 

Portafusibile a tenuta stagna per fusibili mini

### KIT PORTAFUSIBILI MINI

**FUS4512** 2 pz 



KIT portafusibili componibili serie mini. Il kit consiste in:

- 1 portaminifusibile con coperchio relativo,
- 2 gommini passacavo sz. 150mm gialli,
- 2 faston.

Marchio Guidoni.

#### articoli correlati

FUS 4508  
FUS4527



### PORTAFUSIBILI MINI STAGNI VOLANTI

**FUS4527** **FUS4527-15** 2 pz 

sezione cavo  
**2.5mm<sup>2</sup>**

sezione cavo  
**1.5mm<sup>2</sup>**

dettagli articoli:

Portafusibili serie mini volanti tipo lamellari 1 via,

Marchio Guidoni.

**articoli correlati**

FUS 4527L  
FUS4508  
FUS4512

**FUS4527L** 2 pz 

Portafusibili led a tenuta stagna volanti per fusibili

serie mini tipo lamellari, sezione cavo 2.5 mm<sup>2</sup>

Marchio Guidoni.

**articoli correlati**

FUS 4527  
FUS4508  
FUS4512

### PORTAFUSIBILI MINI LED

**FUS4545** 1 pz. 

Portafusibili serie mini led tipo lamellari 4 vie, sezione cavo 4mm<sup>2</sup>

in caso di fusibile bruciato si accende il led corrispondente  
Marchio Guidoni.

**articoli correlati**

FUS4540  
FUS4527  
FUS4512

**FUS4546** 1 pz. 

Portafusibili serie mini led tipo lamellari 6 vie,

in caso di fusibile bruciato si accende il led corrispondente

Marchio Guidoni.

**articoli correlati**

FUS 4541  
FUS4527  
FUS4512



### 3- fusibili e portafusibili



#### FUS4547

1 pz. 

Portafusibili serie mini led tipo lamellari 10 vie,  
in caso di fusibile bruciato si accende il led corrispondente

Marchio Guidoni.

**articoli correlati**  
FUS 4542



#### FUS4529

1 pz. 

Kit portafusibili serie mini 7 vie.  
all'interno di questo kit troverai:

- portafusibile
  - 14 gommini passacavo,
  - 14 faston ed un coperchio semitrasparente.
- Marchio mta

**articoli correlati**  
FUS 4508  
FUS4527  
FUS4512

### FUSIBILI MAXI



Fusibili serie maxi lamellari e led lamellari .  
I modelli led segnalano quando un fusibile ha un malfunzionamento illuminandosi.

Marchio Guidoni,

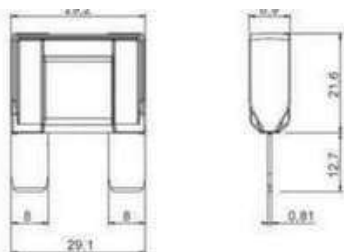

CODICE	AMPERE	COLORE	TIPO	CF. 
FUS4100	20A	GIALLO		10PZ.
FUS4101	30A	VERDE		10PZ.
FUS4102	40A	ARANCIONE		10PZ.
FUS4103	50A	ROSSO		10PZ.
FUS4104	60A	BLU		10PZ.
FUS4105	70A	BEIGE		10PZ.
FUS4106	80A	TRASPARENTE		10PZ.
FUS4107	100A	VIOLA		10PZ.
FUS4072	20A	GIALLO	LED	4PZ.
FUS4073	30A	VERDE	LED	4PZ.
FUS4074	40A	ARANCIONE	LED	4PZ.
FUS4075	50A	ROSSO	LED	4PZ.
FUS4076	60A	BLU	LED	4PZ.
FUS4077	70A	BEIGE	LED	4PZ.
FUS4078	80A	TRASPARENTE	LED	4PZ.
FUS4079	100A	VIOLA	LED	4PZ.



### 3- fusibili e portafusibili



#### KIT FUSIBILI MAXI

##### **FUS4099**

Kit fusibili serie maxi tipo lamellari.  
nel kit troverai 32 fusibili maxi così divisi:  
2 fusibili da 20 ampere,  
2 da 30 ampere,  
2 da 40 ampere,  
2 da 50 ampere,  
2 da 60 ampere,  
2 da 70 ampere,  
2 da 80 ampere,  
2 da 100 ampere.

Marchio Guidoni,

##### articoli correlati

FUS4014  
FUS4467  
FUS4468

#### MAXI FUSIBILI LAMELLARI 80V

##### **Materiale:**

Rame, stagnato adatto per l'uso in applicazioni a bassa tensione fino a 80V DC capacità di rottura 1000A, A 80 VDC rigidità della lama grazie alla costruzione  
Marchio Guidoni,



CODICE	AMPERE	VOLT	COLORE	CF.
FUS4100-80	20	80V	GIALLO	2PZ.
FUS4101-80	30	80V	VERDE	2PZ.
FUS4102-80	40	80V	BEIGE	2PZ.
FUS4103-80	50	80V	ROSSO	2PZ.
FUS4104-80	60	80V	AZZURRO	2PZ.
FUS4105-80	70	80V	MARRONE	2PZ.
FUS4106-80	80	80V	BIANCO	2PZ.
FUS4107-80	100	80V	VIOLA	2PZ.



### PORTAFUSIBILI MAXI



**FUS4502**

5 pz.

Portafusibili componibili serie maxi 1 via,  
Marchio mta.

**articoli correlati**

FUS 4533  
TER 1327  
TER 1329



**FUS4533**

5 pz.

Portafusibili serie maxi 1 via,

Marchio mta.

**articoli correlati**

FUS4526L  
FUS4502



**FUS4551**

1 pz.

Kit portamaxi fusibile stagno per cavo **4->6mm<sup>2</sup>**  
completo di terminali gommini e coperchio



**FUS4552**

1 pz.

Kit portamaxi fusibile stagno per cavo **6->10mm<sup>2</sup>**  
completo di terminali gommini e coperchio

### PORTAFUSIBILI MAXI STAGNI



**FUS4526**

2 pz.

Portafusibili serie maxi stagni volanti 1 via,  
sezione cavo **10mm<sup>2</sup>**

Marchio Guidoni

**articoli correlati**

FUS4526L  
FUS4502  
FUS 4533



**FUS4526L**

2 pz.

Portafusibili LED a tenuta stagna, volanti, a 1 via  
per fusibili serie maxi tipo lamellari.  
Marchio Guidoni

**articoli correlati**

FUS4626  
FUS4502

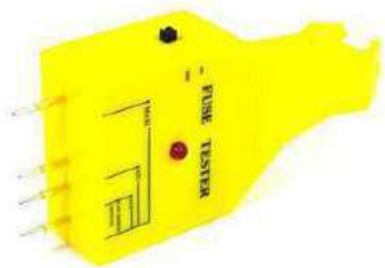

#### TESTER PROVA - FUSIBILI

**FUS4000** 1 pz. 

Tester prova fusibili serie mini-uni-maxi tipo lamellari,  
Marchio Guidoni,

#### articoli correlati

FUS4115  
FUS4104  
FUS 4007



#### FUSIBILI MAXICOMPACT

CODICE	AMPERE	CF. 
FUS4084	25A	10PZ.
FUS4085	30A	10PZ.
FUS4086	35A	10PZ.
FUS4087	40A	10PZ.
FUS4088	50A	10PZ.
FUS4089	60A	10PZ.

#### KIT FUSIBILI MAXICOMPACT

**FUS4090** 1 pz. 

Kit fusibili serie maxicompact.  
Composto da 24 pezzi assortiti.



#### FUSIBILI M8COMPACT

Fusibili serie m8compact, solidi e pratici, con un design  
all'avanguardia,

Marchio mta.



CODICE	AMPERE	CF. 
FUS4091	30A	10PZ.
FUS4092	35A	10PZ.
FUS4093	40A	10PZ.
FUS4094	50A	10PZ.
FUS4095	60A	10PZ.
FUS4096	70A	10PZ.
FUS4097	80A	10PZ.

## 3- fusibili e portafusibili

### KIT FUSIBILI M8COMPACT



**FUS4098**

1 pz.

Kit fusibili serie m8compact composto da 28 pezzi assortiti.

### FUSIBILI MICRO 3

Fusibili micro 3 lamellari, si distinguono per i 3 terminali allineati, collegati con un terminale centrale in comune a tutti.



CODICE	AMPERE	COLORE	CF.
FUS4469	5A	BEIGE	10PZ.
FUS4470	7,5A	MARRONE	10PZ.
FUS4471	10A	ROSSO	10PZ.
FUS4472	15A	BLU	10PZ.

### KIT FUSIBILI MICRO 3

**FUS4468**

1 pz.

Kit fusibili serie micro 3. Un assortimento di qualità per un totale di 20 componenti. troverai:

5 da 3,5AMP,  
5 da 7,5AMP,  
5 da 10AMP,  
5 da 7,5AMP,  
5 da 10AMP,  
5 da 15AMP.

**articoli correlati**

FUS 4467  
FUS 4140  
FUS 4119

### portafusibili micro 3 con derivazione



**FUS4475**

2 pz.

Portafusibili con derivazione per fusibili micro 3



#### FUSIBILI MICRO 2



CODICE	AMPERE	COLORE	CF. 
FUS4460	5A	BEIGE	20 PZ.
FUS4461	7,5A	MARRONE	20 PZ.
FUS4462	10A	ROSSO	20 PZ.
FUS4463	15A	BLU	20 PZ.
FUS4464	20A	GIALLO	20 PZ.
FUS4465	25A	TRASPARENTE	20 PZ.
FUS4466	30A	VERDE	20 PZ.

#### KIT FUSIBILI MICRO 2

##### FUS4467

1 pz. 

Kit fusibili serie micro per FCA  
dentro il box troverai:

70 fusibili micro2, così assortiti:

10 fusibili micro da 5AMP,

10 da 7,5 AMP,

10 da 15AMP,

10 da 20AMP,

10 da 30AMP.

##### **articoli correlati**

FUS4468

FUS4140

FUS4119

#### PORTAFUSIBILI MICRO 2

##### FUS4538

5 pz. 

Portafusibili micro 2 stagni.

#### PORTAFUSIBILI ADD-A-CIRCUIT MICRO 2

##### FUS4459

2 pz. 

Portafusibili ADD-A-CIRCUIT con derivazione per fusibili micro 2,

una novità per raddoppiare la sicurezza del tuo circuito

##### **articoli correlati**

FUS4467

### 3- fusibili e portafusibili

#### FUSIBILI LOW PROFILE



Fusibili LOW profile e LOW profile LED. I modelli LED segnalano quando un fusibile ha un malfunzionamento illuminandosi.

Marchio Guidoni.

CODICE	AMPERE	COLORE	TIPO	CF. 
FUS4130	2	GRIGIO		10PZ.
FUS4131	3	VIOLA		10PZ.
FUS4132	4	ROSA		10PZ.
FUS4133	5	BEIGE		10PZ.
FUS4134	7,5	MARRONE		10PZ.
FUS4135	10	ROSSO		10PZ.
FUS4136	15	BLU		10PZ.
FUS4137	20	GIALLO		10PZ.
FUS4138	25	TRASPARENTE		10PZ.
FUS4139	30	VERDE		10PZ.
FUS4142	2	VERDE	LED	10PZ.
FUS4143	3	VIOLA	LED	10PZ.
FUS4144	4	ROSA	LED	10PZ.
FUS4145	5	BEIGE	LED	10PZ.
FUS4146	7,5	MARRONE	LED	10PZ.
FUS4147	10	ROSSO	LED	10PZ.
FUS4148	15	BLU	LED	10PZ.
FUS4149	20	GIALLO	LED	10PZ.
FUS4150	25	BIANCO	LED	10PZ.
FUS4151	30	VERDE	LED	10PZ.



#### FUSIBILI LOW PROFILE CON PRESA DI CORRENTE

Marchio Guidoni.

CODICE	SEZIONE DEL CAVO	COLORE	PEZZI
FUS 4154	10 AMPERE	ROSSO	5 PEZZI
FUS 4155	15 AMPERE	BLU	5 PEZZI
FUS 4156	20 AMPERE	GIALLO	5 PEZZI
FUS 4157	25 AMPERE	BIANCO	5 PEZZI
FUS 4158	30 AMPERE	VERDE	5 PEZZI



## 3- fusibili e portafusibili

### KIT FUSIBILI LOW PROFILE



#### FUS4140

Dentro il box troverai **70** fusibili LOW PROFILE delle seguenti tipologie:

10 da 5 AMP,  
10 da 7,5 AMP,  
10 da 10 AMP,  
15 da 15 AMP,  
20 da 20 AMP,  
25 da 25 AMP,  
30 da 30 AMP,  
Marchio Guidoni.

#### articoli correlati

FUS 4467  
FUS 4468  
FUS 4119

### PORTAFUSIBILI ADD-A-CIRCUIT LOW PROFILE



#### FUS4141

2 pz. 

Portafusibili add-a-circuit con derivazione per fusibili low profile.

Marchio Guidoni.

#### articoli correlati

FUS 4140

### FUSIBILI MIDI

Marchio Guidoni.



CODICE	AMPERE	COLORE	CF. 
FUS4412	30A	ARANCIO	10PZ.
FUS4410	40A	VERDE	10PZ.
FUS4407	50A	ROSSO	10PZ.
FUS4413	60A	GIALLO	10PZ.
FUS4408	80A	TRASPARENTE	10PZ.
FUS4414	70A	MARRONE	10PZ.
FUS4409	100A	BLU	10PZ.
FUS4411	125A	ROSA	10PZ.
FUS4415	150A	AZZURRO	10PZ.
FUS4416	200A	VIOLA	10PZ.



### PORTAFUSIBILI MIDI



**FUS4532** 1 pz. 

Portafusibili serie midi  
Marchio Guidoni.

#### **articoli correlati**

FUS 4335

FUS 4513



**FUS4514** 2 pz. 

Portafusibili per fusibili midi,  
Marchio Guidoni.



**FUS4417** 2 pz. 

Portafusibili per fusibili midi, tipo littelfuse



**FUS4515** 1 pz. 

Kit portamidi fusibile tenuta stagna per cavo >25MMQ  
portata ,massima 150AMP con staffa di fissaggio a parete  
completo di terminali e 3 fusibili



**FUS4548** 1 pz. 

Scatola portafusibili 4 midi + 1 mega,  
Marchio Guidoni.



**FUS4548-1** 1 pz. 

Scatola portafusibili 7 midi +1mega

### 3- fusibili e portafusibili



**FUS4562**

1 pz.

Morsetto con portamidi fusibili 2 vie

### FUSIBILI MEGA

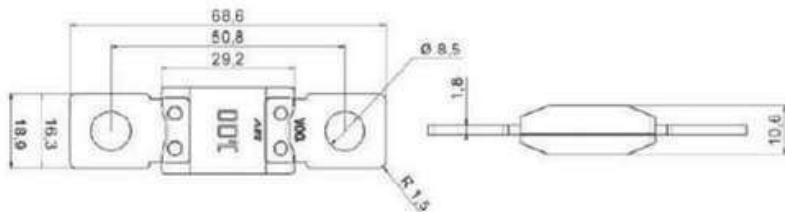

CODICE	AMPERE	COLORE	CF.
FUS4388	40A	NERO	2 PZ.
FUS4389	60A	NERO	2 PZ.
FUS4390	80A	NERO	2 PZ.
FUS4400	100A	GIALLO	2 PZ.
FUS4401	125A	VERDE	2 PZ.
FUS4402	150A	ARANCIONE	2 PZ.
FUS4403	175A	BIANCO	2 PZ.
FUS4404	200A	BLU	2 PZ.
FUS4405	225A	BEIGE	2 PZ.
FUS4406	250A	ROSA	2 PZ.
FUS4397	300A	GRIGIO	2 PZ.
FUS4398	400A	VIOLA	2 PZ.
FUS4399	500A	MARRONE	2 PZ.

### FUSIBILI MEGA TERMICI "CAL"

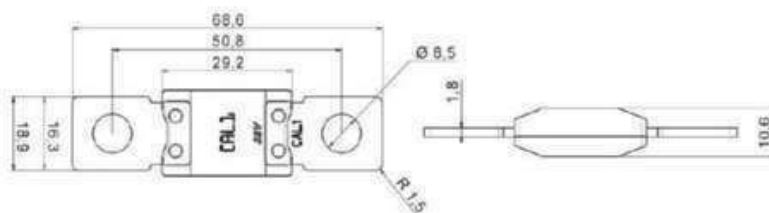

CODICE	CAL	COLORE	CF.
FUS4391	CAL 1	GRIGIO	2 PZ.
FUS4392	CAL 2	NERO	2 PZ.
FUS4393	CAL 3	ROSSO	2 PZ.
FUS4394	CAL 4	MARRONE	2 PZ.
FUS4395	CAL 5	BEIGE	2 PZ.



#### PORTAFUSIBILI MEGA



**FUS4509** 2 pz. 

Portafusibili componibili serie mega.

**articoli correlati**

FUS4534  
TER1371  
TER1372



**FUS4539** 1 pz. 

Portafusibili per fusibili mega.



**FUS4560** 1 pz. 

Porta mega fusibile con coperchio e alloggiamento per fusibile di scorta **viti M8**

**temperatura di lavoro**-40°+125\*

da 40AMP->300AMP

**massimo voltaggio in continuo** 300AMP



**FUS4561** 1 pz. 

Porta mega fusibile componibile tappo rosso in silicone  
VITI M8

**temperatura di lavoro** -40°+105\*

DA 40AMP- >500AMP

**serraggio raccomandato** 25mm minimo

#### KIT PORTAFUSIBILI MEGA



**FUS4528** 1 pz. 

Kit portafusibili con morsetto batteria serie mega tipo occhielli 1 via.

**articoli correlati:**

FUS4509  
FUS4531  
FUS4536



**FUS4534** 1 pz. 

Portafusibili componibili serie mega marchio littlefuse.

**articoli correlati**

FUS 4531  
FUS 4509  
FUS 4528



### 3- fusibili e portafusibili

#### KIT PORTAFUSIBILI MIDI-MEGA



**FUS4531** 1 pz.

Kit portafusibili serie midi-mega.

**articoli correlati**

FUS4528

FUS4536

**FUS4536** 1 pz.



Kit portafusibili elettrici serie midi-mega, 4 vie, specifico per IVECO DAILY, e FIAT DUCATO. include un portafusibile, 2 gommini passacavo, 2 terminali ed un coperchio rigido.

**articoli correlati**

FUS4509

FUS4528

FUS4531

#### PORTAFUSIBILI TRAZIONE 80V



**FUS4450** 1 pz.

Portafusibili serie trazione 80v tipo in ceramica 1 via, Marchio omega.

**articoli correlati**

FUS4423

#### FUSIBILI TRAZIONE 80V CON CERAMICA

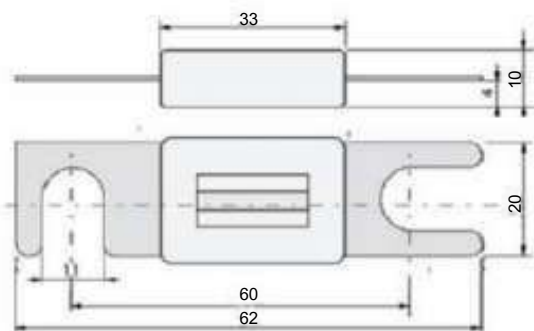

CODICE	AMPERE	CF.
FUS4420	20A	2 PZ.
FUS4421	25A	2 PZ.
FUS4422	35A	2 PZ.
FUS4423	40A	2 PZ.
FUS4424	50A	2 PZ.
FUS4425	63A	2 PZ.
FUS4426	80A	2 PZ.
FUS4427	100A	2 PZ.
FUS4428	125A	2 PZ.
FUS4429	160A	2 PZ.
FUS4430	175A	2 PZ.
FUS4431	200A	2 PZ.
FUS4432	225A	2 PZ.
FUS4433	250A	2 PZ.
FUS4434	275A	2 PZ.
FUS4435	300A	2 PZ.
FUS4436	325A	2 PZ.
FUS4437	355A	2 PZ.
FUS4438	400A	2 PZ.
FUS4439	425A	2 PZ.
FUS4440	500A	2 PZ.



### 3- fusibili e portafusibili

#### FUSIBILI IN CERAMICA 58V

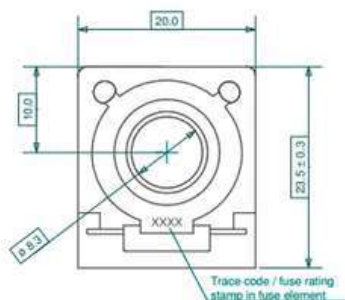

CODICE	AMPERE	CF.
FUS4480	30A	2 PZ.
FUS4481	40A	2 PZ.
FUS4482	50A	2 PZ.
FUS4483	60A	2 PZ.
FUS4484	75A	2 PZ.
FUS4485	80A	2 PZ.
FUS4486	100A	2 PZ.
FUS4487	125A	2 PZ.
FUS4488	150A	2 PZ.
FUS4489	175A	2 PZ.
FUS4490	200A	2 PZ.
FUS4491	250A	2 PZ.
FUS4492	300A	2 PZ.

#### FUSIBILI A NASTRO CON FORCELLA

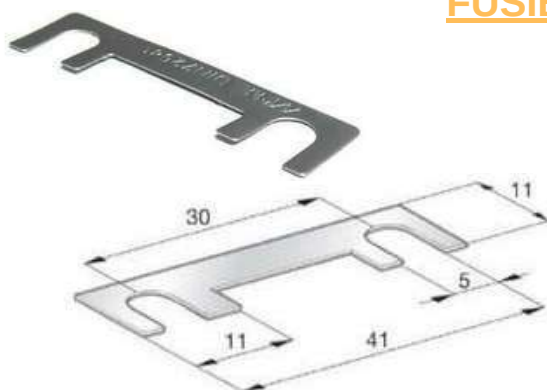

CODICE	AMPERE	CF.
FUS4326	40A	50PZ.
FUS4327	50A	50PZ.
FUS4328	60A	50PZ.
FUS4329	80A	50PZ.

#### FUSIBILI A NASTRO CON OCCHIELLI

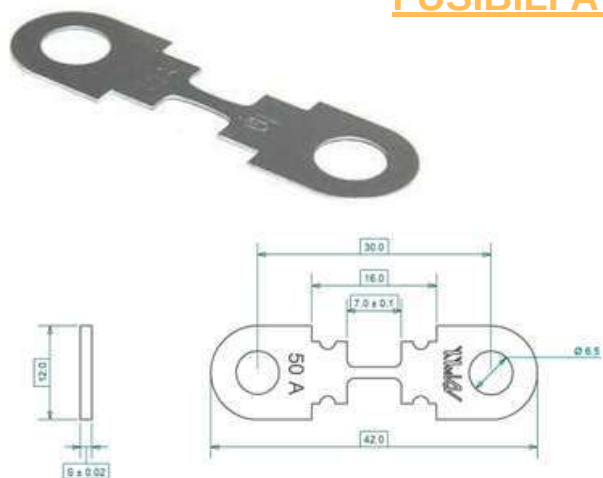

CODICE	AMPERE	CF.
FUS4330	30A	25PZ.
FUS4331	40A	25PZ.
FUS4332	50A	25PZ.
FUS4333	60A	25PZ.
FUS4335	80A	25PZ.
FUS4336	110A	25PZ.
FUS4338	150A	25PZ.
FUS4339	175A	25PZ.

#### PORTAFUSIBILI A NASTRO



##### FUS4513

5pz

Portafusibili serie a nastro e midi tipo con occhielli 1 via, Marchio mta.

##### articoli correlati

FUS4335  
FUS4532  
FUS4329



### 3- fusibili e portafusibili

#### FUSIBILI IN VETRO 5 X 20



CODICE	AMPERE	CF. 
FUS4305	1 A	50PZ.
FUS4306	2 A	50PZ.
FUS4307	3 A	50PZ.
FUS4308	4 A	50PZ.
FUS4309	5 A	50PZ.
FUS4310	6 A	50PZ.
FUS4311	8 A	50PZ.
FUS4312	9 A	50PZ.
FUS4313	10 A	50PZ.
FUS4314	15 A	50PZ.
FUS4315	20 A	50PZ.

#### FUSIBILI IN VETRO 6,3 X 32

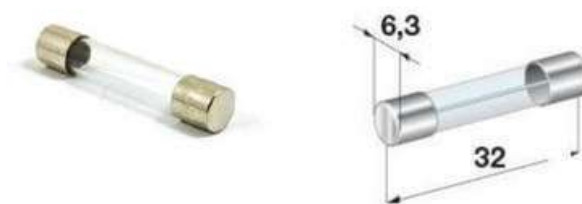

CODICE	AMPERE	CF. 
FUS4316	2 A	50PZ.
FUS4317	3 A	50PZ.
FUS4318	5 A	50PZ.
FUS4319	10 A	50PZ.
FUS4320	16 A	50PZ.
FUS4321	20 A	50PZ.
FUS4322	25 A	50PZ.
FUS4324	7,5 A	50PZ.
FUS4325	30 A	50PZ.



#### FUS4525

25pz. 

Portafusibili per fusibili vetro serie 5x20mm

Marchio Guidoni.

**articoli correlati**  
FUS4307

#### FUSIBILI VECCHIO TIPO CILINDRICI



CODICE	AMPERE	COLORE	CF. 
FUS4300	8A	NERO	100PZ.
FUS4301	16A	VERDE	100PZ.
FUS4302	25A	MARRONE	100PZ.
FUS4303	40A	ROSSO	100PZ.

#### PORTAFUSIBILI CILINDRICI



#### FUS4503

10pz. 

Portafusibili serie cilindrici tipo in bachelite 1 via,

Marchio Guidoni.

**articoli correlati**  
FUS4501  
FUS4300



#### FUSIBILI SERIE JCASE

misure: 14 x 12 x 27,2 mm

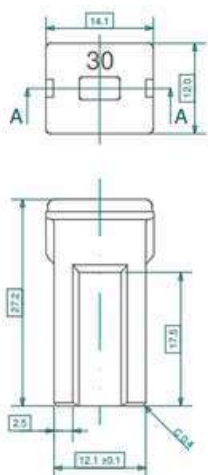

CODICE	AMPERE	COLORE	CF. 
FUS4240	20A	AZZURRO	2 PZ.
FUS4241	30A	ROSA	2 PZ.
FUS4242	40A	VERDE	2 PZ.
FUS4243	50A	ROSSO	2 PZ.
FUS4244	60A	GIALLO	2 PZ.
FUS4245	70A	MARRONE	2 PZ.
FUS4246	80A	NERO	2 PZ.

#### FUSIBILI MINI JCASE

misure: 14,1 x 12 x 15,9 mm

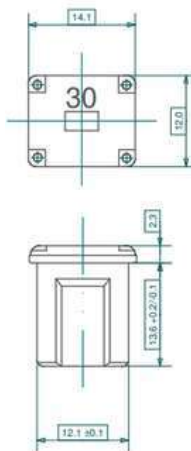

CODICE	AMPERE	COLORE	CF. 
FUS4250	20A	AZZURRO	2 PZ.
FUS4251	25A	TRASPARENTE	2 PZ.
FUS4252	30A	ROSA	2 PZ.
FUS4253	40A	VERDE	2 PZ.
FUS4254	50A	ROSSO	2 PZ.
FUS4255	60A	GIALLO	2 PZ.

#### FUS4549

2 pz. 

Portafusibile per fusibile jcase da FUS4240 A FUS4246 DA FUS4250 A FUS4255

Marchio Guidoni.



#### FUSIBILI MICRO JCASE

misure: 14,1 x 12 x 15,9 mm

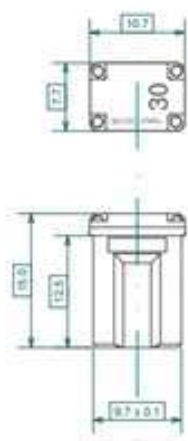

CODICE	AMPERE	COLORE	CF. 
FUS4256	15A	GRIGIO	2 PZ.
FUS4257	20A	AZZURRO	2 PZ.
FUS4258	25A	TRASPARENTE	2 PZ.
FUS4259	30A	ROSA	2 PZ.
FUS4260	40A	VERDE	2 PZ.

### 3- fusibili e portafusibili

#### FUSIBILI SERIE AS

misure: 24,3 x 16 x 32,5 mm

CODICE	AMPERE	COLORE	CF. 
FUS4230	20A	AZZURRO	2 PZ.
FUS4231	30A	ROSA	2 PZ.
FUS4232	40A	VERDE	2 PZ.
FUS4234	50A	ROSSO	2 PZ.
FUS4235	60A	GIALLO	2 PZ.
FUS4236	80A	NERO	2 PZ.
FUS4237	100A	BLU	2 PZ.

#### FUSIBILI SERIE D

CODICE	AMPERE	COLORE	CF. 
FUS4203	25A	MARRONE	2 PZ.
FUS4204	30A	VERDE	2 PZ.

#### FUSIBILI SERIE E

misure: 23 x 15,9 x 38,8mm

CODICE	AMPERE	COLORE	CF. 
FUS4205	45A	ROSSO	2 PZ.
FUS4206	65A	NERO	2 PZ.
FUS4207	75A	GRIGIO	2 PZ.

#### FUSIBILI SERIE JM

misure: 10,7 x 7,7 x 17,5mm

CODICE	AMPERE	COLORE	CF. 
FUS4262	15A	OCRA	2 PZ.
FUS4263	20A	AZZURRO	2 PZ.
FUS4264	25A	GIALLO	2 PZ.
FUS4265	30A	ROSA	2 PZ.
FUS4266	40A	VERDE	2 PZ.
FUS4267	50A	ROSSO	2 PZ.

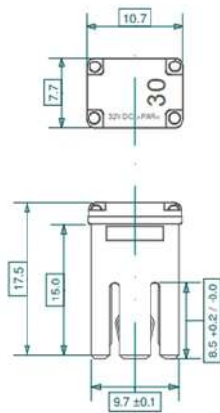
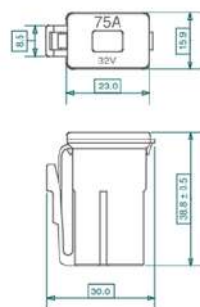
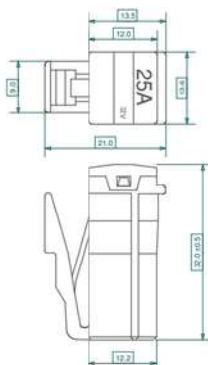
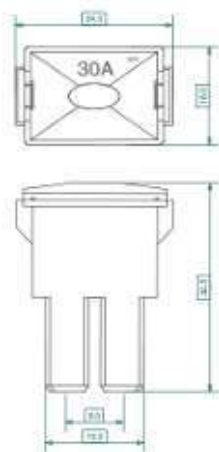
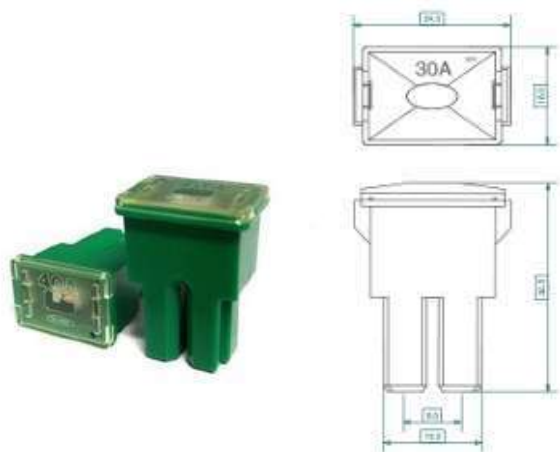

### 3- fusibili e portafusibili

#### FUSIBILI SERIE B MASCHIO

misure: 22,2 x 15,2 x 24,5 (+20,5) mm

CODICE	AMPERE	COLORE	CF. 
FUS4210	30A	ROSA	2 PZ.
FUS4211	40A	VERDE	2 PZ.
FUS4212	50A	ROSSO	2 PZ.
FUS4213	60A	GIALLO	2 PZ.
FUS4214	80A	NERO	2 PZ.
FUS4215	100A	BLU	2 PZ.
FUS4216	120A	TRASPARENTE	2 PZ.
FUS4217	140A	ROSSO MATTONE	2 PZ.

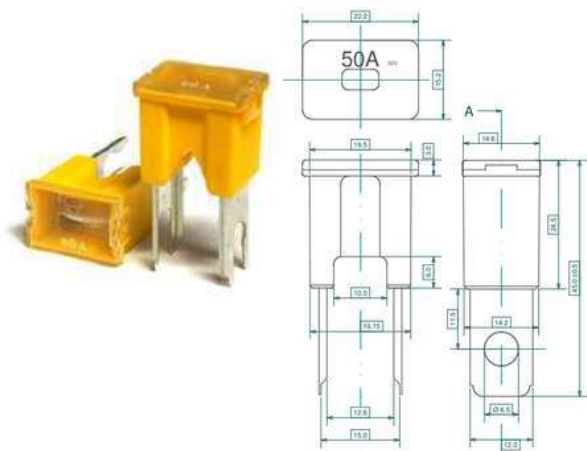

#### FUSIBILI SERIE C MASCHIO

misure: 22 (+40) x 15,2 x 22,2 mm

CODICE	AMPERE	COLORE	CF. 
FUS4220	30A	ROSA	2 PZ.
FUS4221	40A	VERDE	2 PZ.
FUS4222	50A	ROSSO	2 PZ.
FUS4223	60A	GIALLO	2 PZ.
FUS4224	80A	NERO	2 PZ.
FUS4225	100A	BLU	2 PZ.

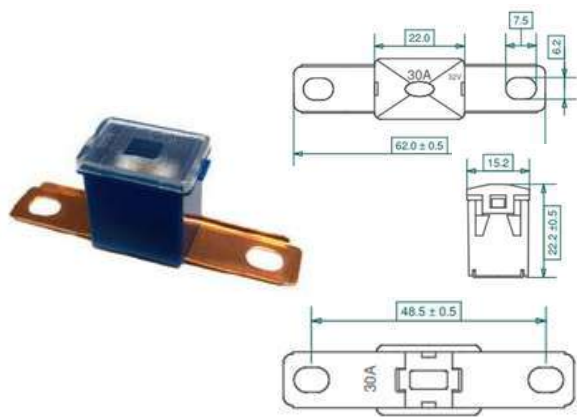

#### FUSIBILI MERCEDES

FUS4451 1 pz. 

Fusibile 6 vie mercedes 5 ampere.

FUS4452 1 pz. 

Fusibile 6 vie mercedes 7,5 ampere.

#### APPLICAZIONI

MB MODEL	MB TYPE	YEAR
ML	W166	>2010
GLE	W167	>2018
C	W205	>2014
E	W213	>2016
S	W222	>2013
E-COUPE	W238	>2016
GLC	W253	>2015
G	W463	>2012
SPRINTER	W907	>2014



## FUSIBILI DI POTENZA RIPRISTINABILI

Marchio Guidoni.



CODICE	AMPERE	CF 
FUS4270	50A	1 PZ.
FUS4271	70A	1 PZ.
FUS4272	80A	1 PZ.
FUS4273	100A	1 PZ.
FUS4274	120A	1 PZ.
FUS4275	150A	1 PZ.
FUS4276	200A	1 PZ.
FUS4278	300A	1 PZ.

## MODULI FRAMES



**FUS4600** 1 pz. 

Coperchi per moduli frames 4 vie.

### articoli correlati

FUS4601  
FUS4608  
FUS4609



**FUS4601** 1 pz. 

Moduli frames (corpo) tipo b 4 vie.

### articoli correlati

FUS4600  
FUS4608  
FUS4609

## MODULI FRAMES TIPO A



**FUS4603** 1 pz. 

Coperchi tipo a per moduli frames 5 vie.

### articoli correlati

FUS4602  
FUS4606  
FUS4607



**FUS4602** 1 pz. 

Moduli frames (corpo) tipo a 5 vie.

### articoli correlati

FUS4603  
FUS4606  
FUS4607



#### MODULI FRAMES



**FUS4608** 1 pz.

Moduli frames per portarele' 2 vie.

**articoli correlati**

TER1383

**FUS4605** 1 pz.

Moduli frames per portafusibili maxi 6 vie.

**articoli correlati**

TER1327

TER1329

**FUS4607** 1 pz.

Moduli frames per portafusibili mini e maxi rele' 10+1 vie.

**articoli correlati**

TER1381

TER1386

TER1324

TER1353

**FUS4604** 1 pz.

Moduli portaminival 20 vie.

**articoli correlati**

TER1381

TER1386

**FUS4609** 1 pz.

Moduli frames per micro-rele' 6 vie.

**articoli correlati**

TER1383

TER1382



**FUS4606**

1 pz.

Moduli frames per porta-rele' e mini-portarele'  
maxi 1+1 vie  
Marchio mta

**articoli correlati**

TER1353  
TER1383

### STAFFE E COPERCHI



**FUS4611**

1 pz.

Coperchi per moduli frames 1 via,  
Marchio mta.

**articoli correlati**

FUS4610



**FUS4610**

2 pz.

Staffa di fissaggio per moduli frames 1 via,  
Marchio mta.

**articoli correlati**

FUS4611



**FUS4613**

1 pz.

Coperchi per moduli frames 2 vie,  
Marchio mta.

**articoli correlati**

FUS4612



**FUS4612**

2 pz.

Staffe per moduli frames 2 vie,  
Marchio mta.

**articoli correlati**

FUS4613