

RELE', INTERRUTTORI

AVVISATORI ACUSTICI
E STACCABATTERIA

4

CAPITOLO 4

- Interruttori, commutatori e pulsanti
- Staccabatteria
- Relè, contattori e intermittenze
- Avvisatori Acustici e riduttori di tensione

RELE', INTERRUTTORI
AVVISATORI ACUSTICI
e STACCABATTERIA





COMMUTATORI LUCI

ELE5500 1 pz. 

Commutatore luci 0-1 specifico per auto fiat 500
Marchio Guidoni.



COMMUTATORI UNIVERSALI

ELE5504 1 pz. 

Commutatore universale a chiave 0-1
Marchio Guidoni.



COMMUTATORI DI AVVIAMENTO

ELE5502 1 pz. 

Commutatore di avviamento a chiave P-0-1-2
Marchio Guidoni.



ELE5520 1 pz. 

Commutatore di avviamento a chiave P-0-1-2
Marchio Guidoni.



ELE5503 1 pz. 

Commutatore di avviamento con preriscaldato
Marchio Guidoni.



ELE5510 1 pz. 

Commutatore di avviamento con 6 attacchi P-1-2
Marchio Guidoni.



COMMUTATORI CLACSON E LUCI

ELE5506 1 pz. 

Commutatore luci e clacson,
0-posizione-anabbagliante- abbagliante-clacson

Marchio Guidoni.



ELE5514 5 pz. 

Commutatore a diretto 0-1

Marchio Guidoni.



DEVIATORE FRECCE

ELE5501 1 pz. 

Deviatore frecce 1-0-1

Marchio Guidoni.



INTERRUTTORI STOP

ELE5211 5 pz. 

Interruttore stop a 2 attacchi

Marchio Guidoni.



ELE5212 2 pz. 

interruttore stop a catenella

Marchio Guidoni.

INTERRUTTORI STOP PER MEZZI AGRICOLI



ELE5210 2 pz. 

Interruttore stop per trattori e mezzi agricoli

Marchio Guidoni.

INTERRUTTORI TONDI 12 V



ELE5611N 5 pz. 

Interruttore 12 volt tondo, colore nero 0-1



ELE5611NB 5 pz. 

Interruttore 12 volt tondo, colore **nero** bipolare 4 faston basculante.

ELE5611P 5 pz. 

Interruttore a pulsante OFF-MOM 12/24 volt tondo, colore **nero** basculante.

ELE5611ND 5 pz. 

Interruttore 12/24 volt tondo, ON-ON deviatore 3 faston colore **nero** basculante



INTERRUTTORI DEVIATORI

ELE5611D 5 pz. 

Interruttore deviator e **I-O-II**
Marchio Guidoni.

INTERRUTTORI LUMINOSI A LED



ELE5611 5 pz. 

Interruttore luminoso a led 0-1 colore **rosso** 12 volt
Marchio Guidoni.



ELE5611V 5 pz. 

Interruttore luminoso 0-1 colore **verde** 12 volt
Marchio Guidoni.



ELE5611B 5 pz. 

Interruttore luminoso 0-1 colore **blu** 12volt
Marchio Guidoni.

4- interruttori commutatori e pulsanti

INTERRUTTORE LED LUMINOSI 0-1 12 VOLT



ELE5611LR 5 pz.

Interruttore con spia luminosa 0-1 di colore **rosso** 12 volt
Marchio Guidoni.

ELE5611LV 5 pz.

Interruttore con spia luminosa 0-1 di colore **verde** 12 volt
Marchio Guidoni.

ELE5611LB 5 pz.

Interruttore tondo on spia luminosa di colore **blu** 12 volt
Marchio Guidoni.

INTERRUTTORE LED LUMINOSI 0-1 24 VOLT



ELE5631 **ELE5632** 2 pz.

COLORE
ROSSO

COLORE
VERDE

ACCESSORI PER INTERRUTTORI



ELE5611E 5 pz.

Cornice tonda per interruttori serie ELE5611

ELE5611T 5 pz.

Cappuccio per interruttore con spia luminosa
verde



SELETTORI



ELE5518 10 pz.

Selettore da incasso. Diametro 20mm. 4 posizioni: 0-1-2-3

ELE5519 10 pz.

Selettore a pomello 0-1-2-3 12V - 23 AMP 24V - 12 AMP foro
per installazione Diametro 12,5mm. 5 contatti da 6,3mm.



KIT INTERRUTTORI TONDI



ELEKIT 1 1 pz.

Kit interruttori tondi con accessori. all'interno troverai:

2pz. **ELE5611N**, 2pz. **ELE5611V**
2pz. **ELE5611D**, 2pz. **ELE5611LR**
2pz. **ELE5611**, 2pz. **ELE5611VL**.



4- interruttori commutatori e pulsanti



SPIE DA INCASSO

ELE5657 5 pz. 

Spia LED tonda da incasso **12volt**, diametro 20mm **rossa**



ELE5658 5 pz. 

Spia LED tonda da incasso **12volt**, diametro 20mm **verde**

INTERRUTTORI E PULSANTI TONDI



ELE5676R 2 pz. 

Interruttore led tondo 12 volt rosso ip65 0-1
Marchio Guidoni.



ELE5676V 2 pz. 

Interruttore led tondo 12 volt verde ip65 0-1
Marchio Guidoni.



ELE5677R 2 pz. 

Pulsante tondo led luminoso rosso, 12 volt, 65 ip on-mom -
diametro 20MM
Marchio Guidoni.



ELE5677V 2 pz. 

Pulsante tondo led luminoso verde, 12 volt, 65 ip on-mom -
diametro 20mm
Marchio Guidoni.



ELE5662 5 pz. 

interruttore tondo on-off, colore nero, diametro 10 mm
Marchio Guidoni.



ELE5660 5 pz. 

Interruttore tondo on-off, colore rosso, diametro 10 mm
Marchio Guidoni.



4- interruttori commutatori e pulsanti

PULSANTI TONDI ON-MOM



ELE5661 5 pz.

Pulsante tondo on-mom, rosso, diametro 10mm
Marchio Guidoni.



ELE5663 5 pz.

Pulsante tondo on-mom nero, diametro 10mm
Marchio Guidoni.

PULSANTI OFF - (ON)



ELE5701R 5 pz.
Pulsante OFF - (ON) N.A. 2P diametro
12mm colore **rosso**



ELE5701B 5 pz.
Pulsante OFF - (ON) N.A. 2P diametro
12mm colore **blu**



ELE5701N 5 pz.
Pulsante OFF - (ON) N.A. 2P diametro
12mm colore **nero**



ELE5701V 5 pz.
Pulsante OFF - (ON) N.A. 2P diametro
12mm colore **verde**

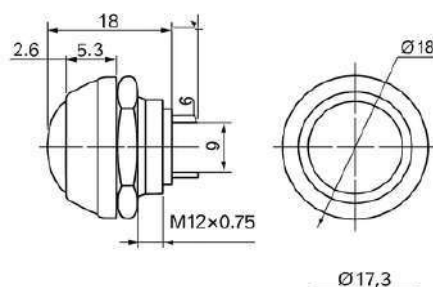

INTERRUTTORI E PULSANTI LED ANTIVANDALO

Completi di connettore cablato

12V



CODICE	TIPOLOGIA	COLORE	DIAMETRO	CF.
ELE5637	INTERRUTTORE LED ON-OFF	VERDE	16mm	2PZ.
ELE5639	INTERRUTTORE LED ON-OFF	ROSSO	16mm	2PZ.
ELE5636	PULSANTE LED ON-MOM	VERDE	16mm	2PZ.
ELE5639B	INTERRUTTORE LED ON-MOM	BLU	16mm	2PZ.
ELE5682	INTERRUTTORE LED ON-OFF	ROSSO	19mm	2PZ.
ELE5638	INTERRUTTORE LED ON-OFF	ROSSO	16mm	2PZ.
ELE5683	INTERRUTTORE LED ON-OFF	VERDE	19mm	2PZ.
ELE5685	PULSANTE LED ON-OFF	BLU	19mm	2PZ.
ELE5680	PULSANTE LED ON-MOM	ROSSO	19mm	2PZ.
ELE5681	PULSANTE LED ON-MOM	VERDE	19mm	2PZ.
ELE5686	LED ON-OFF	BLU	19mm	2PZ.



4- interruttori commutatori e pulsanti



ELE5688 2 pz.

Pulsante led rosso 12 v, 18 a, **diametro 22 mm**

Marchio Guidoni.



ELE5689 2 pz.

Interruttore led rosso 12 v, 18 a, **diametro 22mm**

Marchio Guidoni.

ELE5689C 2 pz.

Connettore cablato per **ELE5689**

Marchio Guidoni.



dettagli articoli:

interruttore o pulsante antivandalo LED **12/24V**
completo di connettore e simboli adesivi diametro
19mm

12/24V

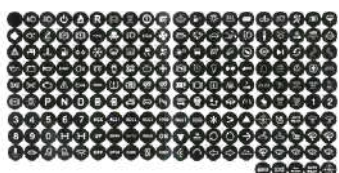

CODICE	TIPO	COLORE	CF.
ELE5731V	INTERRUTTORE	VERDE	2PZ.
ELE5730V	PULSANTE	VERDE	2PZ.
ELE5731R	INTERRUTTORE	ROSSO	2PZ.
ELE5730R	PULSANTE	ROSSO	2PZ.
ELE5731B	INTERRUTTORE	BLU	2PZ.
ELE5730B	PULSANTE	BLU	2PZ.



INTERRUTTORI MCRO A LEVA

ELE5604 5 pz.

Interruttore micro a leva cablato a 5 fili on- off

Marchio Guidoni.



ELE5643 5 pz.

Interruttore micro **SENZA** leva con pulsante

Marchio Guidoni.



ELE5622 10 pz.

Interruttore micro a leva corta con rotella

Marchio Guidoni.



4- interruttori comunicatori e pulsanti



ELE5644 5 pz. 
Interruttore micro a leva lunga senza rotella
Marchio Guidoni.



ELE5642 5 pz. 
Interruttore micro a leva lunga con rotella 15 ampere
Marchio Guidoni.

INTERRUTTORI FINE CORSA



ELE5649 2 pz. 
Interruttore a leva corta con rotella
Marchio Guidoni.



ELE5647 2 pz. 
Interruttore a pulsante
Marchio Guidoni.



ELE5648 2 pz. 
Interruttore con perno filettato e rotella
Marchio Guidoni.

INTERRUTTORI A LEVA



CODICE	TIPOLOGIA	COLORE	ATTACCHI	CF. 
ELE5615	ON-OFF			5PZ.
ELE5620	ON-OFF			5PZ.
ELE5620L	ON-OFF	ROSSO		2PZ.
ELE5623	cappuccio per interruttori a leva			10PZ.
ELE5630	bipolare ON-OFF a leva		4 attacchi	5PZ.
ELE5640	(ON)-OFF con ritorno			5PZ.
ELE5641	(ON)-OFF-(ON) con ritorno		3 attacchi	5PZ.
ELE5664	(ON)-ON		6 attacchi	2PZ.
ELE5667	ON-OFF-ON		6 attacchi	2PZ.
ELE5668	bipolare ON-OFF-ON con ritorno		6 attacchi	2PZ.
ELE5665	ON-ON		3 attacchi	2PZ.
ELE5675	connettore per interruttori a leva			5PZ.



KIT INTERRUTTORI A LEVA



ELE KIT2

Kit interruttori a leva con accessori, All'interno della confezione troverai:

- 2PZ: ELE5620, • 1PZ: ELE5630,
- 2PZ: ELE5615, • 1PZ: ELE5667,
- 1PZ: ELE5665, • 1PZ: ELE5668,
- 1PZ: ELE5640, • 5PZ: ELE5623,
- 1PZ: ELE5641, • 10PZ: ELE5675,
- 1PZ: ELE5644, • 50PZ: TER1109

INTERRUPTORI A TENUTA STAGNA

ELE5620C 2 pz.

Interruttore a leva ON-OFF bipolare cablato con cavetti da 20cm IP67 con led luminoso OFF **rosso** ON **verde**



ELE5615C 2 pz.

Interruttore a leva ON-OFF-ON bipolare cablato con cavetti da 20cm IP67 con led luminoso OFF **rosso** ON **verde**

ELE5668C 2 pz.

Interruttore a leva (ON)-OFF-(ON) bipolare cablato 6 attacchi con ritorno, cavetti da 20cm IP67 con led luminoso OFF **rosso** ON **verde**

PROTEZIONI DI SICUREZZA

ELE5617 5 pz.

Protezione di sicurezza rossa
Marchio Guidoni.



ELE5618 5 pz.

Protezione di sicurezza nera
Marchio Guidoni.



CAPPUCCI PER INTERRUTTORI A LEVA

ELE5623 10 pz.

Cappuccio per interruttori a leva
Marchio Guidoni.



INTERRUTTORI ON - OFF

CON SPIA LUMINOSA E CHIUSURA DI PROTEZIONE



CODICE	COLORE	CONFEZIONAMENTO
ELE5620LA	LED ARANCIO	2PZ.
ELE5620LBI	LED BIANCO	2PZ.
ELE5620LBL	LED BLU	2PZ.
ELE5620LR	LED ROSSO	2PZ.
ELE5620LV	LED VERDE	2PZ.

SPIE LED CON DIAMETRO Ø 20



CODICE	VOLT	COLORE	CONFEZIONAMENTO
ELE5692	12	ROSSO	2 PEZZI
ELE5693	24	ROSSO	2 PEZZI
ELE5694	12	ARANCIO	2 PEZZI
ELE5695	24	ARANCIO	2 PEZZI
ELE5696	12	VERDE	2 PEZZI
ELE5697	24	VERDE	2 PEZZI
ELE5698	12	BLU	2 PEZZI
ELE5699	24	BLU	2 PEZZI

BUZZER A LED



ELE5690 1 pz. 

Buzzer a led 12 V rosso diametro 22mm
Marchio Guidoni.



ELE5691 1 pz. 

Buzzer a led 24 V rosso Buzzer a led 24 V rosso
diametro 22mm
Marchio Guidoni.



ELE5687-12 2 pz. 

Buzzer da pannello, diametro 22mm 70DB - 12V
Marchio Guidoni.

ELE5687-24 2 pz. 

Buzzer da pannello, diametro 22mm 70DB - 24V
Marchio Guidoni.

4- interruttori commutatori e pulsanti

SPIE LED CABLATE 8mm



Spia a led 12V E 24V, diametro **8mm**,

Marchio Guidoni.

CODICE	VOLT	COLORE	CARATTERISTICA	CONFEZIONAMENTO
ELE5603	12	NERO	Luce lampeggiante	5 PEZZI
ELE5605	12	ROSSO	Luce fissa	5 PEZZI
ELE5650	12	VERDE	Luce fissa	5 PEZZI
ELE5652	12	GIALLO	Luce fissa	5 PEZZI
ELE5655	12	BLU	Luce fissa	5 PEZZI
ELE5654	24	ROSSO	Luce fissa	5 PEZZI
ELE5651	24	VERDE	Luce fissa	5 PEZZI
ELE5653	24	GIALLO	Luce fissa	5 PEZZI
ELE5656	24	BLU	Luce fissa	5 PEZZI



SPIE LED CABLATE 6mm

Spia a led 12V , diametro **6mm**,

CODICE	VOLT	COLORE	DIAMETRO	CONFEZIONAMENTO
ELE5700V	12V	VERDE	6MM	5PZ.
ELE5700B	12V	BIANCO	6MM	5PZ.
ELE5700BL	12V	BLU	6MM	5PZ.
ELE5700G	12V	GIALLO	6MM	5PZ.
ELE5700R	12V	ROSSO	6MM	5PZ.

SPIE LUMINOSE ROSSE



ELE5606

5 pz. 

Spia luminosa rossa, per lampade BA9S diametro 16mm.
Marchio Guidoni.

SPIE CABLATE LUMINOSE



CODICE	VOLT	COLORE	CF. 
ELE5612-1	12/24V	ROSSO	5PZ.
ELE5612-2	12/24V	ARANCIO	5PZ.
ELE5612-3	12/24V	BLU	5PZ.
ELE5612-4	12/24V	BIANCO	5PZ.
ELE5626-1	12/24V	VERDE	5PZ.



PRESE ACCENDISIGARI USB E ACCESSORI



ELE5629 1 pz. 

Preso, fissaggio a pannello, completa di coperchio
Marchio Guidoni.



ELE5629 P 2 pz. 

Preso 12 v piccola con coperchio e fissaggio a pannello
Marchio Guidoni.



ELE5625 1 pz. 

Preso universale completa di coperchio
Marchio Guidoni.



ELE5625V 1 pz. 

Preso universale completa di coperchio e ghiera a vite
Marchio Guidoni.



ELE5628 1 pz. 

Preso usb doppia, 3.1 ampere. da pannello, cablata. 12/24v
Marchio Guidoni.



ELE5628QC 1 pz. 

Preso usb doppia QC, 3.0+40QC. carica veloce da pannello.

Marchio Guidoni.



ELE5703 1 pz. 

Preso usb doppia QC, 3.0 30W. Tipo C PD. Con coperchio antipolvere e chiusura automatica



ELE5704 1 pz. 

Preso usb doppia QC, 3.0 . Tipo C PD. Con coperchio stagno

4- interruttori commutatori e pulsanti



ELE5704QC

1 pz. 

Presse usb doppia QC, 3.0 36W. Tipo C PD 60W. Fissaggio base piana con cornice e coperchio stagno



ELE5628AC

2 pz. 

presa usb doppia 2.4 ampere per accendisigari

Marchio Guidoni.



ELE5628A

1 pz. 

Voltmetro illuminato da incasso

Marchio Guidoni.



ELE5628Z

1 pz. 

Amperometro da incasso illuminato 12/24 per misurazioni fin o a 100 ampere

Marchio Guidoni.



ELE5628C

2 pz. 

Cilindro di protezione per le ELE5628/ELE5629/ELE5629P

Marchio Guidoni.



ELE5628S

2 pz. 

Supporto di montaggio a 1 foro per ELE5628

Marchio Guidoni.



ELE5628S-1

2 pz. 

Supporto di montaggio a 1 foro per ELE5628 adatto per moto

Marchio Guidoni.



CORNICI DI FISSAGGIO



ELE5628-1

1 pz.

Cornice di fissaggio a pannello 1 posizione per
ELE5625USB - ELE5628

Marchio Guidoni.



ELE5628-2

1 pz.

Cornice di fissaggio a pannello 2 posizioni per
ELE5625USB - ELE5628 - ELE5628VA - ELE5629

Marchio Guidoni.



ELE5628-1B

1 pz.

Cornice di fissaggio da esterno 1 posizione per
ELE5625USB ELE5628 - ELE5628VA - ELE5629

Marchio Guidoni.



ELE5628-2B

1 pz.

Cornice di fissaggio da esterno 2 posizioni per
ELE5625USB ELE5628 - ELE5628VA - ELE5629

Marchio Guidoni.

PULSANTI CROMATI A BOTTONE



ELE5619

5 pz.

Pulsante di segnale cromato a bottone normalmente aperto
diametro testa **19mm**
diametro filetto **15mm**

Marchio Guidoni.

PULSANTI DIAVVIAMENTO



ELE5659

2 pz.

Pulsante di avviamento led **rosso** Diametro **22mm**
12V 50A, 24 V 45 A

Marchio Guidoni.



ELE5634

5 pz.

Pulsante di avviamento Diametro 22mm

Marchio Guidoni.



4- interruttori commutatori e pulsanti



ELE5635

5 pz. 

Pulsante di avviamento con cappuccio. Diametro **22mm**

Marchio Guidoni



ELE5621G

5 pz. 

Pulsante di avviamento grande.

Diametro testa **22mm** ,diametro filetto **18mm**

Marchio Guidoni.



ELE5621P

5 pz. 

Pulsante di avviamento piccolo.

Diametro testa **19mm** ,diametro filetto **16mm**

Marchio Guidoni.



ELE5669

2 pz. 

Pulsante di avviamento con bottone cromato

Marchio Guidoni.



ELE5670

2 pz. 

Pulsante di avviamento piccolo, filettatura frontale

Marchio Guidoni.



ELE5671

1 pz. 

Pulsante di avviamento **12 AMP** a 2 contatti,
filettatura frontale per nautica

Marchio Guidoni.



ELE5671P

1 pz. 

Pulsante di avviamento nautico di potenza **50 AMP**,
12VOLT filettatura frontale

applicazioni:
Auto, nautica, truck

Marchio Guidoni.



Y1009

1 pz. 

Pulsante a pedale per luci clacson

Marchio Guidoni.



4- interruttori commutatori e pulsanti

PULSANTI PORTIERE E ANTIFURTO

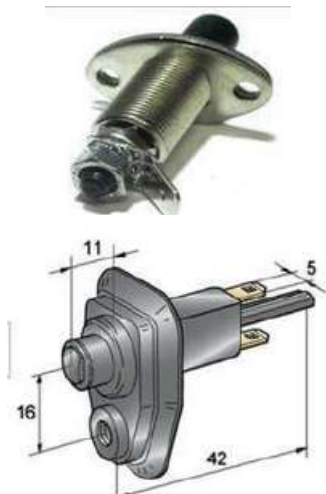

EURG060 10 pz.

Pulsante per antifurto

Y3535 1 pz.

Interruttore portiere



ELE5208 1 pz.

Kit contattiera. Fissa + mobile 3 VIE



ELE5209 1 pz.

Kit contattiera. Fissa + mobile 2 VIE

INTERRUTTORI ALZACRISTALLI UNIVERSALI



ELE5672 1 pz.

Interruttore 5 attacchi alzacristalli universale luminoso
Marchio Guidoni.



ELE5673 1 pz.

Interruttore 6 attacchi alzacristalli universale luminoso
Marchio Guidoni.



ELE5673C 1 pz.

Connettore cablato per ELE5673
Marchio Guidoni.



INTERRUTTORI DA PANNELLO LED



CODICE	INTERRUTTORE	PIN	COLORE	PEZZI
ELE 5100	ON-ON	4 PIN SPDT	BLU	1 PEZZO
ELE 5105	ON-OFF-ON	4 PIN SPDT	BLU	1 PEZZO
ELE 5110	(ON)-OFF-ON	4 PIN SPDT	BLU	1 PEZZO
ELE 5115	(ON)-OFF- (ON)	4 PIN SPDT	BLU	1 PEZZO
ELE 5120	ON-OFF	3 PIN SPDT	BLU	1 PEZZO
ELE 5125	ON-OFF	4 PIN SPDT	BLU	1 PEZZO
ELE 5130	ON-OFF	5 PIN SPDT	BLU	1 PEZZO
ELE 5135	(ON)-OFF	5 PIN SPDT	BLU	1 PEZZO



CODICE	INTERRUTTORE	PIN	COLORE	PEZZI
ELE 5101	ON-ON	4 PIN SPDT	VERDE	1 PEZZO
ELE 5106	ON-OFF-ON	4 PIN SPDT	VERDE	1 PEZZO
ELE 5111	(ON)-OFF-ON	4 PIN SPDT	VERDE	1 PEZZO
ELE 5116	(ON)-OFF- (ON)	4 PIN SPDT	VERDE	1 PEZZO
ELE 5121	ON-OFF	3 PIN SPDT	VERDE	1 PEZZO
ELE 5126	ON-OFF	4 PIN SPDT	VERDE	1 PEZZO
ELE 5131	ON-OFF	5 PIN SPDT	VERDE	1 PEZZO
ELE 5136	(ON)-OFF	5 PIN SPDT	VERDE	1 PEZZO



CODICE	INTERRUTTORE	PIN	COLORE	PEZZI
ELE 5102	ON-ON	4 PIN SPDT	ARANCIONE	1 PEZZO
ELE 5107	ON-OFF-ON	4 PIN SPDT	ARANCIONE	1 PEZZO
ELE 5112	(ON)-OFF-ON	4 PIN SPDT	ARANCIONE	1 PEZZO
ELE 5117	(ON)-OFF- (ON)	4 PIN SPDT	ARANCIONE	1 PEZZO
ELE 5122	ON-OFF	3 PIN SPDT	ARANCIONE	1 PEZZO
ELE 5127	ON-OFF	4 PIN SPDT	ARANCIONE	1 PEZZO
ELE 5132	ON-OFF	5 PIN SPDT	ARANCIONE	1 PEZZO
ELE 5137	(ON)-OFF	5 PIN SPDT	ARANCIONE	1 PEZZO



CODICE	INTERRUTTORE	PIN	COLORE	PEZZI
ELE 5103	ON-ON	4 PIN SPDT	ROSSO	1 PEZZO
ELE 5108	ON-OFF-ON	4 PIN SPDT	ROSSO	1 PEZZO
ELE 5113	(ON)-OFF-ON	4 PIN SPDT	ROSSO	1 PEZZO
ELE 5118	(ON)-OFF- (ON)	4 PIN SPDT	ROSSO	1 PEZZO
ELE 5123	ON-OFF	3 PIN SPDT	ROSSO	1 PEZZO
ELE 5128	ON-OFF	4 PIN SPDT	ROSSO	1 PEZZO
ELE 5133	ON-OFF	5 PIN SPDT	ROSSO	1 PEZZO
ELE 5138	(ON)-OFF	5 PIN SPDT	ROSSO	1 PEZZO



4- interruttori commutatori e pulsanti



ELE5150

2 pz. 

Cornice finale per interruttori a pannello 5100-> 5139
Marchio Guidoni.



ELE5151

2 pz. 

Cornice centrale per interruttori a pannello 5100-> 5139
Marchio Guidoni.



ELE5152

2 pz. 

Copriforo a pannello



ELE5153

5 pz. 

Copriforo a pannello
Marchio Guidoni.



ELE5154

2 pz. 

Connettore 8 poli



ELE5155

2 pz. 

Utensile di rimozione
Marchio Guidoni.



ELE5156

2 pz. 

Foglio adesivo con simboli



4- interruttori commutatori e pulsanti

PULSANTI DA SPONDA IDRAULICA



IND8082 1 pz.

Pulsante arancione sponda idraulica N.O - N.C
Marchio Guidoni.



IND8083 1 pz.

Pulsante verde sponda idraulica **24 VOLT** N.O - N.C
Marchio Guidoni.



IND8084 2 pz.

Segnalatore led arancione per sponda idraulica

12-24 VOLT

Marchio Guidoni.



IND8084 RIC 2 pz.

Segnalatore led sponda idraulica-**24 VOLT** a batteria
Marchio Guidoni.

PULSANTIERA PENSILE



Y554 1 pz.

Pulsantiera emergenza pensile 4 funzioni.
Marcia indietro marcia avanti



Y555 1 pz.

Pulsantiera pensile 2 funzioni. avanti- dietro



ELE5220 1 pz.

Joystick manipolatore 4 posizioni





SPIRALI MULTIPOLARI 12-24V

CODICE	SEZ. CAVI	N° CAVI	CF. 
IND8045	0,75mm ²	3	6 mt.
IND8046	0,75mm ²	7	4,5 mt.
IND8047	0,75mm ²	2	4 mt.



IND8047

Spirale pvc per girevoli 2x0.75 mt

PULSANTI DI EMERGENZA



ELE5678

1 pz. 

Pulsante di emergenza rosso sblocco a rotazione led colore **ROSSO/VERDE** diametro 22 mm **12-24 VOLT** con connettore cablato



ELE5214

1 pz. 

Interruttore di emergenza a fungo. foro m20
Marchio Guidoni.



ELE5218

1 pz. 

Contatto per ELE5214 n.c. confezione



ELE5215

1 pz. 

Etichetta emergenza / stop



ELE5216

1 pz. 

Supporto per ELE5214
misure: 64x69x38

Marchio Guidoni.



ELE5217

1 pz. 

Supporto tondo per ELE5214
misure: 89x37



STACCA-ATTACCA BATTERIE CON CHIAVE



ELE5747 1 pz.

Staccabatteria con chiave rossa, resistenza e contatti ausiliari
1200AMP con viti **M10**
Marchio Guidoni.

STACCABATTERIA CON CHIAVE 500 AMPERE



Marchio Guidoni.

CODICE	AMPERE	VITI	CONFEZIONAMENTO
ELE5750	500	M.8	1 PEZZO
ELE5748	500	M.10	1 PEZZO

ELE5749 5 pz.

Chiavetta di ricambio staccabatteria
Marchio Guidoni.



ELE5755 1 pz.

Stacca-attacca batteria con chiave **100-500 AMP**
Marchio Guidoni.



ELE5756 1 pz.

Stacca-attacca batteria con chiave **150 AMP**
Marchio Guidoni.



dettagli articoli:
Staccabatteria / Selettore da pannello

LEAD FREE ROHS 2011/65/EU - COMPLIANT

CODICE	AMPERE	MISURE	CF.
ELE5759	100A	Ø450 X h500mm	1PZ.
ELE5759-1	200A	Ø550 X h650mm	1PZ.
ELE5759-2	300A	Ø700 X h750mm	1PZ.



ELE5740

1 pz. 

Staccabatteria a selettore da pannello **300A 12-
>48V** con morsetto
misure: 35x55x48mm



ELE5757

1 pz. 

Stacca-attacca batteria con chiave **300 AMP**
Marchio Guidoni.

SELETTORI PER BATTERIE



ELE5758-1

1 pz. 

Selettore per batteria **300 AMP 1-OFF-2** da pannello o
da esterno. massimo voltaggio **32VDC**

misure: larghezza 7,5CM
altezza 6CM altezza pulsante 2CM

STACCA BATTERIE A CHIAVE ESTRAIBILE



ELE5753

1 pz. 

Staccabatteria a chiave estraibile **300AMP 24VOLT**
Marchio Guidoni.

STACCA BATTERIE PER IVECO



ELE5743

1 pz. 

Staccabatteria on-off
200 AMP continui,
100 AMP di picco
con asola per blocco e con lucchetto
misure: altezza 140mm - diametro 60mm



ELE5751

1 pz. 

Staccabatteria tipo IVECO **250AMP 24VOLT**
Marchio Guidoni



4- staccabatteria



ELE5745 1 pz.

Staccabatteria tipo IVECO con staffa di fissaggio **250AMP - 2500AMP** per 3 secondi



ELE5746 1 pz.

Stacca batteria tipo IVECO con contatto ausiliario e maniglia fissa, riferimento iveco 99458665

250AMP - 2500AMP per 3 secondi



ELE5741 1 pz.

Staccabatteria
12/24 VOLT
200 AMP
con chiave fissa contatti ausiliari con connettori superseal

STACCA BATTERIE CON POMELLO



ELE5742 1 pz.

Staccabatteria con pulsante di emergenza
200 AMP



ELE5744 **ELE5744-24** 1 pz.

12VOLT
180 AMP

24VOLT
180 AMP

dettagli articoli

Staccabatteria elettronico con telecomando, particolarmente indicato per vetture/ furgoni/ camper



ELE5446 1 pz.

Relè separatore di batteria automatico
12VOLT
125 AMP continui
140 AMP di picco



SCHEMI ELETTRICI RELÈ

Accanto a molti relè troverai associato il nome di uno schema elettrico.
In questa pagina potrai visionare nel dettaglio gli schemi elettrici corrispondenti.

1AD	 NORMALMENTE APERTO	 DIODE 1N4007	1BD	 NORMALMENTE APERTO	 DIODE 1N4007
1AR	 NORMALMENTE APERTO	 DIODE 1N4007	1BR	 NORMALMENTE APERTO	 DIODE 1N4007
2AD	 NORMALMENTE APERTO	 DIODE 1N4007	2BD	 NORMALMENTE APERTO	 DIODE 1N4007
2AR	 NORMALMENTE APERTO	 12V-5600 / 24V-15000	2BR	 NORMALMENTE APERTO	 12V-5600 / 24V-15000
3AD	 SCAMBIO	 DIODE 1N4007	3BD	 SCAMBIO	 DIODE 1N4007
3AR	 SCAMBIO	 12V-5600 / 24V-15000	3BR	 SCAMBIO	 12V-5600 / 24V-15000
A			C		
B			D		

4- rele' contattori e intermittenze

F			N		
H			O		
I			Mini-1		
P			Mini-2		
Q			Mini-3		
L			Mini-4		
M					

MINI RELE' 12 VOLT



ELE5407

5 pz.

Relè mini con resistenza normalmente aperto **30AMP 12VOLT**

schema tecnico mini 1

Marchio Guidoni.



ELE5406

5 pz.

Relè mini con resistenza di scambio, fissaggio **10/20 AMP**

12VOLT

schema tecnico mini-3

Marchio Guidoni.



4- rele' contattori e intermittenze



ELE5424

4 pz. 

Relè mini di scambio con diodo, fissaggio **15/25AMP 12VOLT**
schema tecnico mini-4

Marchio Guidoni.



ELE5425

4 pz. 

Relè, mini con diodo, fissaggio - n.a. **25AMP 12VOLT**

Marchio Guidoni.

schema tecnico mini 2

RELE' 12 VOLT



ELE5412

ELE5412B

5pz. 

Marchio
Guidoni

Marchio
Bosch

Relè a servizio continuo n.a con resistenza, fissaggio con
staffa removibile, **40AMP 12VOLT**
schema tecnico 2-Br



ELE5416

ELE5416B

5pz. 

Marchio
Guidoni

Marchio
Bosch

Relè a servizio continuo deviatore in scambio con
resistenza,
fissaggio con staffa removibile, **20/30AMP 12VOLT**
schema tecnico 3-Br



ELE5404

4 pz. 

Relè **30AMP 12VOLT** con
diodo Marchio Guidoni.
schema tecnico 2-bd



ELE5405

4 pz. 

Relè con diodo di scambio, fissaggio con staffa removibile
20/30AMP

Marchio Guidoni.

schema tecnico 3-bd





ELE5414

4 pz. 

Relè n.a con 87 separati, fissaggio con staffa removibile
2x20AMP 12 VOLT

Marchio Guidoni.

schema tecnico: TIPO-f



ELE5403

4 pz. 

Relè con fusibile resistenza normalmente aperto,
fissaggio con staffa removibile **30AMP 12 VOLT**

schema tecnico: TIPO a

Marchio Guidoni.



ELE5401

5 pz. 

Relè con fusibile di scambio **12VOLT** trasparente, contatti
in rame, spia led, staffa removibile
schema tecnico: 3br



ELE5434

1 pz. 

Kit relè + porta relais stagno **30/40 AMP 12VOLT**
in scambio con resistenza
schema tecnico: 3br



ELE5435

1 pz. 

Kit relè + porta relais stagno 12 v 30/40 ampere in
scambio con diodo

schema tecnico: 3bd



ELE5436

1 pz. 

Kit relè + porta relais stagno 12 v 40 ampere n.a.
con resistenza

schema tecnico:2br

MINI E MICRO RELAIS



ELE5480

4 pz. 

Mini micro relè 280, 12 v, 20 ampere n/a
con resistenza, 4 piedini



ELE5481

2 pz. 

Mini micro relè 280, 12V, 12AMP, n/a
con resistenza, 4 piedini



ELE5482

2 pz. 

Micro relè 280, 12V, 12AMP, in scambio
con resistenza, 5 piedini

RELE' DI POTENZA 12 VOLT



ELE5410

4 pz. 

Relè di potenza, fissaggio con staffa removibile
70 AMP 12V.

schema tecnico: TIPO -c
Marchio Guidoni.



ELE5426

2 pz. 

Relè di potenza di scambio, fissaggio **70-60 AMP 12V.**
schema tecnico: TIPO-d
Marchio Guidoni.



ELE5411

2 pz.

Relè di potenza fissaggio con staffa **200AMP 12 volt**

Marchio Guidoni.

schema tecnico: TIPO-I



ELE5411-1

1 pz.

Relè di potenza fissaggio **230 AMP 12VOLT** (160 ampere continuo) 4 poli - 2 viti m8 - 2 terminali 6.3

Marchio Guidoni.

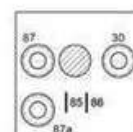
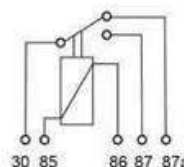
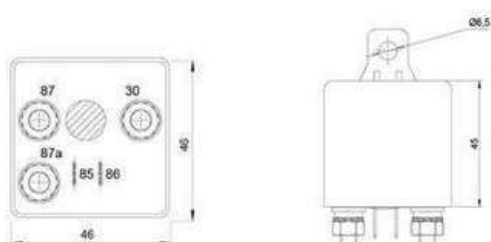

ELE5411-2

1 pz.

Relè di potenza fissaggio **230 AMP 12VOLT** (160 ampere continuo) 5 poli - 3 viti m8 - 2 terminali 6.3

Marchio Guidoni.

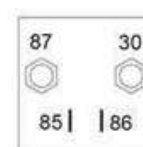
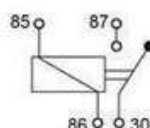
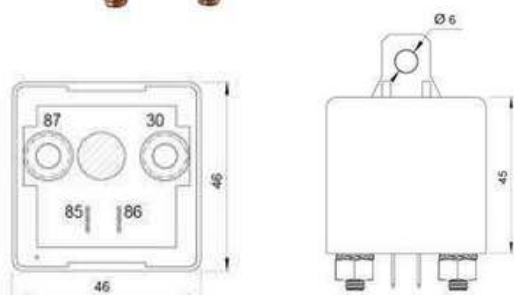

RELE' FLIP-FLOP 12 VOLT



ELE5449

1 pz.

Rele' flip flop, permette di utilizzare un pulsante come interruttore, fissaggio con staffa removibile **12VOLT**

Marchio Guidoni.



MINI RELE' 24 VOLT

ELE5458

4 pz.

Relè mini con resistenza di scambio **20 AMP 24VOLT**
schema tecnico: mini-3

Marchio Guidoni.



ELE5460

4 pz.

Rele' mini resistenza normalmente aperto **20 AMP 24VOLT**
schema tecnico: mini-1

Marchio Guidoni.



ELE5462

4 pz.

Rele' mini di scambio con diodo, fissaggio con staffa
removibile **24VOLT**
schema tecnico: mini-4

Marchio Guidoni.

RELE' 24 VOLT



ELE5452

Marchio Guidoni

5pz.

ELE4552B

Marchio Bosch

5pz.

Relè con resistenza, fissaggio con staffa removibile
22 AMP 24 VOLT

schema tecnico: 2br

Marchio Guidoni



ELE5454

Marchio Guidoni

5pz.

ELE4554B

Marchio Bosch

5pz.

Rele' in scambio con resistenza, fissaggio con staffa
removibile **10 AMP 24 VOLT**

schema tecnico: 3br

4- rele' contattori e intermittenze



ELE5457

4 pz. 

Relè di scambio a diodo, fissaggio con staffa removibile
20AMP 24 VOLT

Marchio Guidoni.

schema tecnico: 3 bo



ELE5461

4 pz. 

Relè con 87 separati, fissaggio con staffa removibile
15AMP 24 VOLT

Marchio Guidoni.

schema tecnico: tipo-f



ELE5451

5 pz. 

Relè con fusibile e resistenza, fissaggio con staffa removibile
20AMP 24 VOLT

Marchio Guidoni.

schema tecnico: tipo-1 a



ELE5437

1 pz. 

Kit relè + porta relè stagno **24VOLT 10/20AMP** in scambio
con diodo

schema tecnico: tipo 3bd

RELE' DI POTENZA 24 VOLT



ELE5455

4 pz. 

Relè di potenza **70AMP, 24VOLT**

schema tecnico: tipo c



ELE5459

2 pz. 

Relè di potenza di scambio, fissaggio con staffa
40-50 AMP, 24VOLT

schema tecnico: tipo-d



4- rele' contattori e intermittenze



ELE5456

2 pz.

Rele' di potenza, fissaggio con staffa **100 AMP, 24VOLT**
schema tecnico: tipo-m

ELE5456 - 1

1 pz.

Rele' di potenza, **180AMP 24VOLT** (120 ampere continuo) 5 poli, 3 viti m8, 2 terminali 6.3

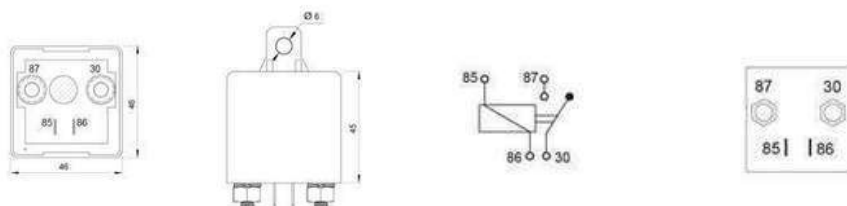

ELE5456 -2

1 pz.

Rele' di potenza, **160/120AMP 24VOLT** (120 /100 ampere continuo) 4 poli, 2 viti m8, 2 terminali 6.3

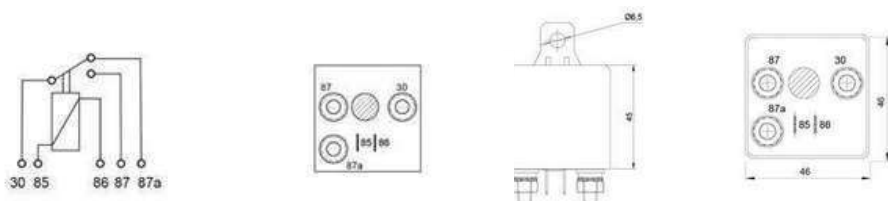

RELE' FLIP-FLOP 24 VOLT



ELE5450

1 pz.

Rele' flip-flop, permette di utilizzare un pulsante come un interruttore, fissaggio con staffa removibile **24VOLT**

RELE' TEMPORIZZATI

il multimer è un relè temporizzato utilizzato per accendere o spegnere un accessorio dopo un tempo di ritardo selezionabile tramite due selettori sul coperchio. il ritardo parte da 0,5 secondi fino a 6 ore. utilizzato con ritardo alla diseccitazione, il temporizzatore può essere azionato da un impulso e può essere innescato da un interruttore o da un pulsante.

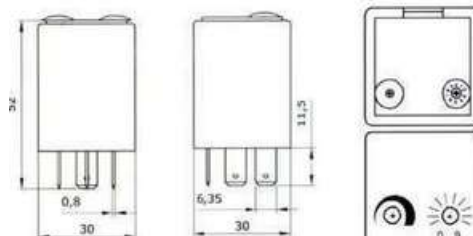

CODICE	AMPERE	VOLT	TEMPO DI RITARDO	TEMPO DI ANTICIPO	CF.
ELE5447	10A	12V	0=0,5...10sec delay off 1=5... 60 sec delay off 2=0,5 10 min delay off 3=5... 60 min delay off 4=0,5...6 h delay off	5=0,5...6h delay on 6=5...60 min delay on 7=0,5...10 min delay 8=5... 60 sec delay on 9=0,5...10 sec delay on	1 PZ.
ELE5448	10A	24V	0=0,5...10sec delay off 1=5... 60 sec delay off 2=0,5 10 min delay off 3=5... 60 min delay off 4=0,5...6 h delay off	5=0,5...6h delay on 6=5...60 min delay on 7=0,5...10 min delay 8=5... 60 sec delay on 9=0,5...10 sec delay on	2 PZ.

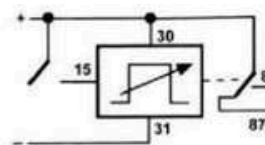
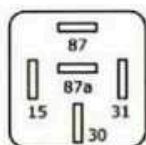

SCHEMA DI RITARDO

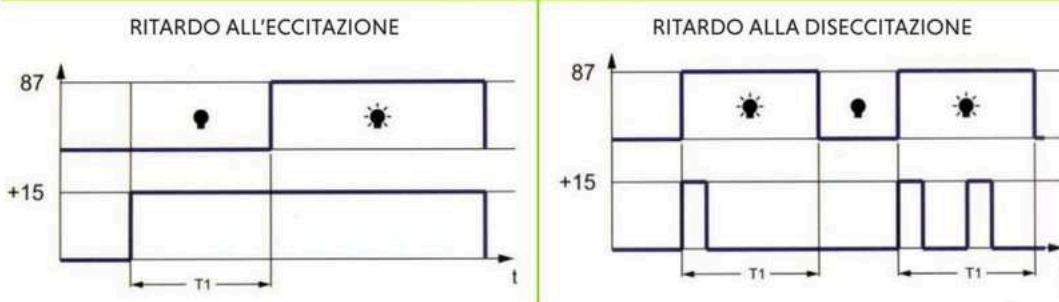

CONTATTORI



ELE5409 1 pz.

Contattore 140 AMP 12 VOLT

schema tecnico: TIPO N

ELE5409-2 1 pz.

Contattore 300AMP 12VOLT

schema tecnico: TIPO N

Marchio Guidoni



4- rele' contattori e intermittenze



ELE5408 1 pz.

Contattore **120 AMP 24 VOLT**
schema tecnico: TIPO o



ELE5408-2 1 pz.

Contattore **200 AMP 24 VOLT**
schema tecnico: 0

Marchio Guidoni

INTERMITTENZE FIAT



ELE5302 2 pz.

Intermittenza a 3 attacchi



ELE5301 2 pz.

Intermittenza frecce 4 attacchi

INTERMITTENZA 12 VOLT



ELE5303 2 pz.

Intermittenza frecce **12VOLT**



ELE5305 2 pz.

Intermittenza **12VOLT** specifica per lampade a led con battito freccia regolabile per vetture europee

INTERMITTENZE 24 VOLT



ELE5304 2 pz.

Intermittenza frecce **24VOLT**



CENTRALINA 12/24V



ELE5311

Centralina **2 AMP 12/24 VOLT**, per mettere il lampeggio delle luci di ingombro laterali.

Dimensioni:

76mmX43mmX21mm

Tensione di funzionamento:

10VDC - 30VDC

Temperatura di funzionamento: -30°C - +60°C

Conessioni:

cavi ADR sciolti - connettori AMP fissaggio: 2 VITI M5 a rondelle

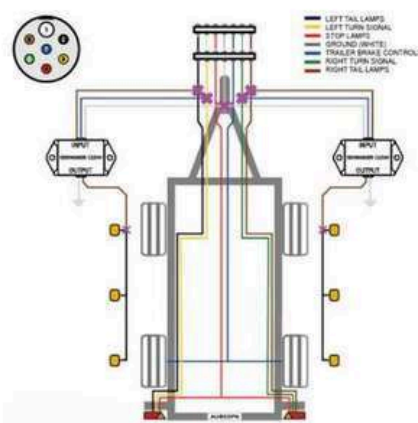
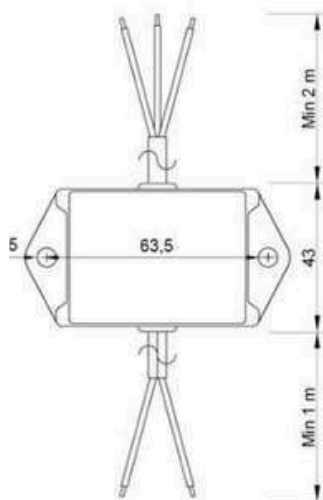

ELE5312



Centralina **2 AMP 12/24 VOLT** per mettere il lampeggio delle luci di ingombro laterali.1. 10-30V dispositivo lampeggiante 2.

Grado di tenuta all'acqua:

IP68 3.

Temperatura di funzionamento: -30 ° C ~ 50 ° C 4. ECE R10 - ECE R48 - REV. 6 7.

Applicazioni:

camion, rimorchi e veicoli di trasporto

AVVISATORI ACUSTICI DA INTERNO



ELE5614

5 pz.

Avvisatore acustico da interno **12 VOLT**

Marchio Guidoni



ELE5633

5 pz.

Avvisatore acustico da interno **24 VOLT**

Marchio Guidoni



AVVISATORI ACUSTICI BUZZER



IND8325 1 pz. 

Avvisatore acustico buzzer **12VOLT** 3 contatti

Marchio Guidoni



IND8326 1 pz. 

Avvisatore acustico buzzer. completo di staffa, **12/24**

VOLT- 3 contatti

Marchio Guidoni



IND8327 1 pz. 

Avvisatore acustico retromarcia, 102 db, **10/110 VOLT**
applicazione carrelli elevatori

Marchio Guidoni



IND8329 1 pz. 

Avvisatore acustico retromarcia **12/24 VOLT**, 87 db con
fili per cablaggio. applicazione truck e mezzi pesanti

Marchio Guidoni



IND8328 1 pz. 

Avvisatore acustico retromarcia **12/24 VOLT**, 102 db.
applicazione truck e mezzi pesanti

Marchio Guidoni



IND8329I 1 pz. 

Avvisatore acustico retromarcia con luci led. **12/24 VOLT**

con filo - 97db

Marchio Guidoni

4- avvisatori acustici e riduttori di tensione



IND8330

1 pz. 

Avvisatore acustico retromarcia **12/24 VOLT** 112 db.
applicazione mezzi pesanti e movimento a terra

Marchio Guidoni



IND8331

1 pz. 

Avvisatore acustico retromarcia **12/24 VOLT** 112 db
per mezzi pesanti

Marchio Guidoni

AVVISATORI ACUSTICI



ELE5801

2 attacchi

12 VOLT

ELE5802

2 attacchi

24 VOLT

2 pz. 

KIT TROMBE 12V



ELE5800/1

1 attacco

12 VOLT

Marchio Guidoni

ELE5800/2

2 attacchi

12 VOLT

2 pz. 

TROMBE SINGOLE



ELE5803/1

1 attacco

12 VOLT

ELE5803/2

2 attacchi

12 VOLT

1 pz. 



ELE5821

1 pz. 

Coppia di trombe **12 VOLT** 2 attacchi da utilizzare
con adattatori ELE5822->ELE5835



4- avvisatori acustici e riduttori di tensione











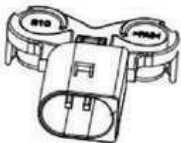





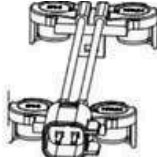

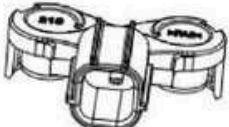
ELE5820

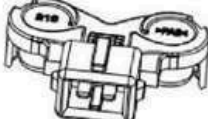
1 pz. 

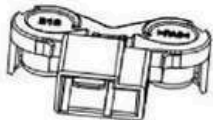

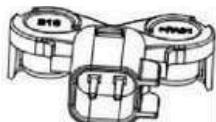





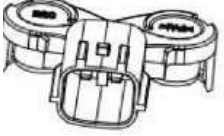

Assortimento adattatori per ELE5821

14 modelli per installazioni su ricambi originali

CODICE	DESCRIZIONE	DISEGNO TECNICO	
ELE 5822	ADATTATORE UNIVERSALE PER ELE5821		UNIVERSALE
ELE 5823	ADATTATORE AUDI PER ELE5821		
ELE 5824	ADATTATORE BMW PER ELE5821		
ELE 5825	ADATTATORE VOLKSWAGEN PER ELE5821		
ELE 5826	ADATTATORE FORD II PER ELE5821		
ELE 5827	ADATTATORE HONDA PER ELE5821		
ELE 5828	ADATTATORE PEUGEOT PER ELE5821		 
ELE 5829	ADATTATORE TOYOTA PER ELE5821		
ELE 5830	ADATTATORE FORD PER ELE5821		 

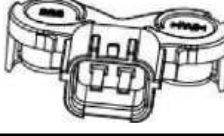

4- avvisatori acustici e riduttori di tensione

CODICE	DESCRIZIONE	DISEGNO TECNICO	
ELE 5831	ADATTATORE HYUNDAI PER ELE5821		
ELE 5832	ADATTATORE BMW PER ELE5821		
ELE 5833	ADATTATORE NEW HONDA PER ELE5821		
ELE 5834	ADATTATORE NEW HYUNDAI PER ELE5821		
ELE 5835	ADATTATORE NEW PEUGEOT PER ELE5821		



ELE5840 1 pz. 

Adattatore cablato **HONDA** per il montaggio da 1 a 2 trombe



ELE5841 1 pz. 

Adattatore cablato **PEUGEOT** per il montaggio da 1 a 2 trombe



ELE5842 1 pz. 

Adattatore cablato **VW** per il montaggio da 1 a 2 trombe



ELE5843 1 pz. 

Adattatore cablato **TOYOTA** per il montaggio da 1 a 2 trombe



4- avvisatori acustici e riduttori di tensione



ELE5844

1 pz. 

Adattatore cablato **FORD** per il montaggio da 1 a 2 trombe



ELE5845

1 pz. 

Adattatore cablato **HYUNDAI** per il montaggio da 1 a 2 trombe



ELE5846

1 pz. 

Adattatore cablato **HONDA** per il montaggio da 1 a 2 trombe



KIT TROMBE 24 V

ELE5804

1 pz. 

Kit trombe 2 attacchi **24VOLT**

Marchio Guidoni



ELE5807

1 pz. 

Kit trombe pneumatiche **24VOLT** per autobus e truck

Marchio Guidoni

RIDUTTORI DI TENSIONE DA 24 VDC A 12 VDC



CODICE	AMPERE	CF. 
IND8120	3A	1PZ.
IND8121	5A	1PZ.
IND8122	10A	1PZ.
IND8123	20A	1PZ.
IND8124	30A	1PZ.



